

## RESIDENTIAL GAS WATER HEATERS

# POLARIS®



POWER DIRECT VENT GAS MODELS  
WITH DIRECT SPARK IGNITION


PR MODELS  
Series 200, 201  
NATURAL GAS & PROPANE



**WARNING:** If the information in these instructions is not followed exactly, a fire or explosion may result causing property damage, personal injury or death.

- Do not store or use gasoline or other flammable vapors and liquids in the vicinity of this or any other appliance.
- WHAT TO DO IF YOU SMELL GAS:
  - Do not try to light any appliance.
  - Do not touch any electrical switch; do not use any phone in your building.
  - Immediately call your gas supplier from a neighbor's phone. Follow the gas supplier's instructions.
  - If you cannot reach your gas supplier, call the fire department.
- Installation and service must be performed by a qualified installer, service agency or the gas supplier.

Thank you for buying this energy efficient water heater. We appreciate your confidence in our products.



### **! WARNING**

Read and understand instruction manual and safety messages before installing, operating or servicing this water heater.

Failure to follow instructions and safety messages could result in death or serious injury.

Instruction manual must remain with water heater.

• **For Your Safety** •  
AN ODORANT IS ADDED TO THE GAS USED BY THIS WATER HEATER.

**ALL TECHNICAL AND WARRANTY QUESTIONS:** SHOULD BE DIRECTED TO THE LOCAL DEALER FROM WHOM THE WATER HEATER WAS PURCHASED. IF YOU ARE UNSUCCESSFUL, CALL THE TECHNICAL SUPPORT PHONE NUMBER SHOWN ON THE WATER HEATER LABELING.

KEEP THIS MANUAL IN THE POCKET ON HEATER FOR FUTURE REFERENCE  
WHEN EVER MAINTENANCE ADJUSTMENT OR SERVICE IS REQUIRED.


# TABLE OF CONTENTS





SAFE INSTALLATION, USE AND SERVICE.....	3	Concentric Vent Installation.....	28
APPROVALS.....	3	Venting Multiple Units.....	29
GENERAL SAFETY INFORMATION.....	4	WATER HEATER INSTALLATION.....	30
Precautions.....	4	Condensate Drain Installation.....	30
Grounding Instructions.....	4	Supply Gas Line Installation.....	30
INTRODUCTION.....	7	Gas Line Leak Testing.....	31
Abbreviations Used.....	7	Purging.....	31
Qualifications.....	7	Electrical Wiring.....	32
Preparing For The Installation.....	7	Water Line Connections.....	32
DIMENSIONS AND CAPACITY DATA.....	8	T&P Valve Discharge Pipe.....	33
Rough In Dimensions: All Models.....	8	TEMPERATURE REGULATION.....	34
FEATURES AND COMPONENTS.....	10	High Temperature Limit Control (ECO).....	34
34 Gallon Unit.....	10	Thermostat Control.....	34
50 Gallon Unit.....	11	CONTROL SYSTEM OPERATION.....	35
Controls And Switches.....	13	Overview.....	35
INSTALLATION CONSIDERATIONS.....	14	Control System Navigation.....	35
Locating The Water Heater.....	14	User Settings & Control System Menus.....	38
Insulation Blankets.....	15	START UP.....	43
Combustion Air And Ventilation.....	15	Start Up Conditions.....	43
Corrosion and Water Quality.....	15	Prior to Start Up.....	43
INSTALLATION REQUIREMENTS.....	16	Filling the Water Heater.....	43
Gas Supply Systems.....	16	Initial Start Up.....	44
Supply Gas Regulator.....	16	LIGHTING THE WATER HEATER.....	45
Power Supply.....	16	Lighting & Operation Labels.....	45
Mixing Valves.....	17	Checking the Firing Rate.....	46
Circulation Pumps.....	17	Gas Input Rate.....	46
Space Heating And Potable Water System.....	18	High Altitude Installations.....	46
Storage Tank Installation.....	18	TROUBLESHOOTING.....	47
Solar Installation.....	18	Installation Checklist.....	47
Closed Water Systems.....	18	Sequence Of Operation.....	47
Thermal Expansion.....	18	Sequence Of Operation Flow Chart.....	48
Temperature-Pressure Relief Valve.....	19	Operational Problems.....	49
Condensate Drain.....	20	Fault And Alert Conditions.....	50
VENTING INSTALLATION.....	21	LEAKAGE CHECKPOINTS.....	52
Vent Installation Considerations.....	21	PERIODIC MAINTENANCE.....	53
General Venting Instructions.....	21	Venting System Inspection.....	53
Approved Vent/Intake Material.....	21	Integrated Filter Preventative Maintenance.....	53
Polypropylene Installations.....	22	Temperature-Pressure Relief Valve Test.....	53
Vent Pipe Termination.....	22	Draining and Flushing.....	54
Planning The Vent System.....	22	Service.....	54
Integrated Filter Installation.....	23	DIAGRAMS.....	55
Direct Vent Air Intake Moisture Protection.....	24	CCB-Central Control Board Layout.....	55
Horizontal Vent Terminal Installation.....	24	Wiring Diagram.....	56
Vertical Vent Terminal Installation.....	25	Circulation Pump Wiring Diagrams.....	57
Termination Clearances Sidewall Direct Vent.....	26	Piping Diagrams.....	58
Direct Vent Installation Diagrams.....	27		

## SAFE INSTALLATION, USE AND SERVICE

The proper installation, use and servicing of this water heater is extremely important to your safety and the safety of others.

Many safety-related messages and instructions have been provided in this manual and on your own water heater to warn you and others of a potential injury hazard. Read and obey all safety messages and instructions throughout this manual. It is very important that the meaning of each safety message is understood by you and others who install, use, or service this water heater.

	<p>This is the safety alert symbol. It is used to alert you to potential personal injury hazards. Obey all safety messages that follow this symbol to avoid possible injury or death.</p>
---	---

	<p>DANGER indicates an imminently hazardous situation which, if not avoided, will result in injury or death.</p>
	<p>WARNING indicates a potentially hazardous situation which, if not avoided, could result in injury or death.</p>
	<p>CAUTION indicates a potentially hazardous situation which, if not avoided, could result in minor or moderate injury.</p>
	<p>CAUTION used without the safety alert symbol indicates a potentially hazardous situation which, if not avoided, could result in property damage.</p>

All safety messages will generally tell you about the type of hazard, what can happen if you do not follow the safety message, and how to avoid the risk of injury.

## APPROVALS



# GENERAL SAFETY INFORMATION

## PRECAUTIONS

DO NOT USE THIS WATER HEATER IF ANY PART HAS BEEN EXPOSED TO FLOODING OR WATER DAMAGE. Immediately call a qualified service technician to inspect the water heater and to make a determination on what steps should be taken next.

If the unit is exposed to the following, do not operate heater until all corrective steps have been made by a qualified service technician.


1. External fire.
2. Damage.
3. Firing without water.

## GROUNDING INSTRUCTIONS

This water heater must be grounded in accordance with the National Electrical Code and/or local codes. These must be followed in all cases. Failure to ground this water heater properly may also cause erratic control system operation.

This water heater must be connected to a grounded permanent wiring system; or an equipment grounding conductor must be run with the circuit conductors and connected to the equipment grounding terminal or lead on the water heater.

**Verify the power to the water heater is turned off before performing any service procedures. The Enable/Disable switch at the base of the water heater disables the 24 volt gas control valve. Electrical supply must be turned off at circuit breaker serving water heater.**



**⚠ WARNING**

Read and understand this instruction manual and the safety messages herein before installing, operating or servicing this water heater.

Failure to follow these instructions and safety messages could result in death or serious injury.

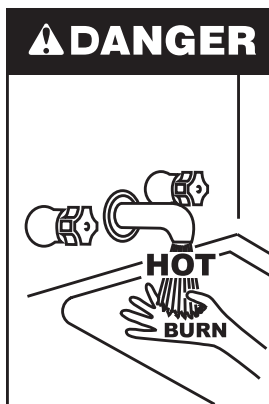
This manual must remain with the water heater.



**⚠ WARNING**

**Explosion Hazard**

- Overheated water can cause water tank explosion.
- Properly sized Temperature - Pressure Relief Valve must be installed in the opening provided.



**⚠ DANGER**

Water temperature over 125°F (52°C) can cause severe burns instantly resulting in severe injury or death.

Children, the elderly and the physically or mentally disabled are at highest risk for scald injury.

Feel water before bathing or showering.

Temperature limiting devices such as mixing valves must be installed when required by codes and to ensure safe temperatures at fixtures.

**CAUTION**


**Improper installation, use and service may result in property damage.**

- Do not operate water heater if exposed to flooding or water damage.
- Install in location with drainage.
- Fill tank with water before operation.
- Properly sized thermal expansion tanks are required on all closed water systems.

Refer to this manual for installation and service.

# GENERAL SAFETY INFORMATION


**⚠ WARNING**



- Before servicing the water heater, make sure the blower assembly is unplugged or the electrical supply to the water heater is turned "OFF".
- Label all wires prior to disconnection when servicing controls. Wiring error can cause improper and dangerous operation. Verify proper operation after servicing.
- Failure to do this could result in death, serious bodily injury, or property damage.

**⚠ WARNING**


**Breathing Hazard - Carbon Monoxide Gas**



- Install vent system in accordance with codes.
- Do not operate water heater if any part has been exposed to flooding or water damage.
- Special Consideration must be taken with installations above 10,100' (3,078m) for standard models.
- Do not operate if soot buildup is present.
- Do not obstruct water heater air intake with insulating jacket.
- Do not place chemical vapor emitting products near water heater.
- Gas and carbon monoxide detectors are available.
- No vent damper installation is compatible with this power vented water heater.
- Condensate lines (field supplied) must not be elevated above the exhaust elbow assembly drain outlet. This must be true for the entire length of the condensate lines including the exit into an appropriate drain.
- Condensate lines must be free and clear of debris and must not allow back flow through the lines. The condensate lines must be able to flow freely to an appropriate drain.
- Do not allow condensate lines to become crimped closed.
- Analyze the entire vent system to make sure that condensate will not become trapped in a section of vent pipe and therefore reduce the open cross sectional area of the vent.

Breathing carbon monoxide can cause brain damage or death.  
 Always read and understand instruction manual.

**⚠ DANGER**




FLAMMABLE
Flammable Vapors

**⚠ Vapors from flammable liquids may explode and catch fire causing death or severe burns.**

Do not use or store flammable products such as gasoline, solvents or adhesives in the same room or area near the water heater.

Keep flammable products:

1. far away from heater,
2. in approved containers,
3. tightly closed and
4. out of children's reach.

Water heater has a main burner and ignition device  
The ignition device:

1. can come on at any time and
2. will ignite flammable vapors.

Vapors:

1. cannot be seen,
2. are heavier than air,
3. go a long way on the floor and
4. can be carried from other rooms to the ignition device by air currents.

# GENERAL SAFETY INFORMATION

## **⚠️ WARNING**

### **Fire or Explosion Hazard**

- Do not store or use gasoline or other flammable vapors and liquids in the vicinity of this or any other appliance.
- Avoid all ignition sources if you smell gas.
- Do not expose gas control valve/thermostat to excessive gas pressure.
- Use only the gas shown on the water heater rating plate.
- Maintain required clearances to combustibles.
- Keep ignition sources away from faucets after extended periods of non-use.

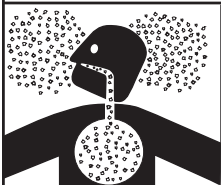


Read instruction manual before installing, using or servicing water heater.



## **⚠️ WARNING**

### **Breathing Hazard - Carbon Monoxide Gas**



- Do not obstruct water heater air intake with insulating blanket.
- Gas and carbon monoxide detectors are available.
- Install water heater in accordance with the instruction manual.

Breathing carbon monoxide can cause brain damage or death. Always read and understand instruction manual.

## **CAUTION**

### **Property Damage Hazard**

- All water heaters eventually leak.
- Do not install without adequate drainage.

## **⚠️ WARNING**

### **Electrical Shock Hazard**



- Turn off power to the water heater before performing any service.
- Label all wires prior to disconnecting when performing service. Wiring errors can cause improper and dangerous operation.
- Verify proper operation after servicing.
- Failure to follow these instructions can result in personal injury or death.

## **⚠️ WARNING**

### **Fire Hazard**



For continued protection against risk of fire:

- Do not install water heater on carpeted floor.
- Do not operate water heater if exposed to flooding or water damage.

## **⚠️ WARNING**

### **Fire and Explosion Hazard**



- Use joint compound or Teflon tape compatible with propane gas.
- Leak test gas connections before placing the water heater in operation.
- Disconnect gas piping at main gas shutoff valve before leak testing.
- Install sediment trap in accordance with CAN/CSA B149.1.

## **⚠️ WARNING**

### **Fire and Explosion Hazard**



- Do not use water heater with any gas other than the gas shown on the rating plate.
- Excessive gas pressure to gas control valve can cause serious injury or death.
- Turn off gas lines during installation.
- Contact a qualified installer or service technician for installation and service.

## **⚠️ WARNING**

**Jumping out control circuits or components can result in property damage, personal injury or death.**

- Service should only be performed by a qualified service technician using proper test equipment.
- Altering the water heater controls and/or wiring in any way could result in permanent damage to the controls or water heater and is not covered under the limited warranty.



Any bypass or alteration of the water heater controls and/or wiring will result in voiding the appliance warranty.





# INTRODUCTION

Thank You for purchasing this water heater. Properly installed and maintained, it should give you years of trouble free service.

## ABBREVIATIONS USED

Abbreviations found in this Instruction Manual include :

- ANSI - American National Standards Institute
- ASME - American Society of Mechanical Engineers
- AHRI - Air-Conditioning, Heating and Refrigeration Institute
- NEC - National Electrical Code
- UL - Underwriters Laboratory
- CSA - Canadian Standards Association

## QUALIFICATIONS

### QUALIFIED INSTALLER OR SERVICE AGENCY

Installation and service of this water heater requires ability equivalent to that of a Qualified Agency (as defined by ANSI below) in the field involved. Installation skills such as plumbing, air supply, venting, gas supply and electrical supply are required in addition to electrical testing skills when performing service.

**ANSI Z223.1 2006 Sec. 3.3.83:** "Qualified Agency" - "Any individual, firm, corporation or company that either in person or through a representative is engaged in and is responsible for (a) the installation, testing or replacement of gas piping or (b) the connection, installation, testing, repair or servicing of appliances and equipment; that is experienced in such work; that is familiar with all precautions required; and that has complied with all the requirements of the authority having jurisdiction."

If you are not qualified (as defined by ANSI above) and licensed or certified as required by the authority having jurisdiction to perform a given task do not attempt to perform any of the procedures described in this manual. If you do not understand the instructions given in this manual do not attempt to perform any procedures outlined in this manual.

### PREPARING FOR THE INSTALLATION

1. Read the entire manual before attempting to install or operate the water heater. Pay close attention to the General Safety Information on Page 4 through Page 6. If you don't follow the safety rules, the water heater may not operate safely. It could cause property damage, injury and/or death.

This manual contains instructions for the installation, operation, and maintenance of the water heater. It also contains warnings throughout the manual that you must read and be aware of. All warnings and all instructions are essential to the proper operation of the water heater and your safety. Detailed installation diagrams are also found in this manual. These

diagrams will serve to provide the installer with a reference. It is essential that all venting, water piping, gas piping and wiring be installed as shown.

Particular attention should be given to the installation of thermometers at the locations indicated in the piping diagrams as these are necessary for checking the operation of the water heater.

The principal components of the water heater are identified in Features and Components beginning on Page 10 in this manual. Use this reference to locate and identify various components on the water heater.

See the Installation Checklist and Troubleshooting on page 47. By using this checklist the user may be able to make minor operational adjustments and avoid unnecessary service calls. However, service and diagnostic procedures should only be performed by a Qualified Service Agency.

**NOTE:** Costs to correct installation errors are not covered under the limited warranty.

2. Be sure to turn off power when working on or near the electrical system of the water heater. Never touch electrical components with wet hands or when standing in water.
3. The installation must conform to all instructions contained in this manual and the local code authority having jurisdiction. These shall be carefully followed in all cases. Authorities having jurisdiction should be consulted before installation begins if there are any questions regarding compliance with local, state or national codes.

In the absence of local codes, the installation must comply with CAN/ CSA-B149.1, the Natural Gas and Propane Installation Code and CSA C22.1, the Canadian Electrical Code. All documents are available from the Canadian Standards Association, 8501 East Pleasant Valley Road, Cleveland, OH 44131.

4. If after reading this manual you have any questions or do not understand any portion of the instructions, call the toll free number on the back cover of this manual for technical assistance. In order to expedite your request, please have the full Model, Serial and Series number of the water heater you are working with available for the technician. This information is located on the water heater's rating plate.
5. Carefully plan the placement of the water heater. Examine the location to ensure that it complies with the requirements in Locating The Water Heater on Page 14 and the Rough In Dimensions on Page 8.

# DIMENSIONS AND CAPACITY DATA

## ROUGH IN DIMENSIONS: ALL MODELS

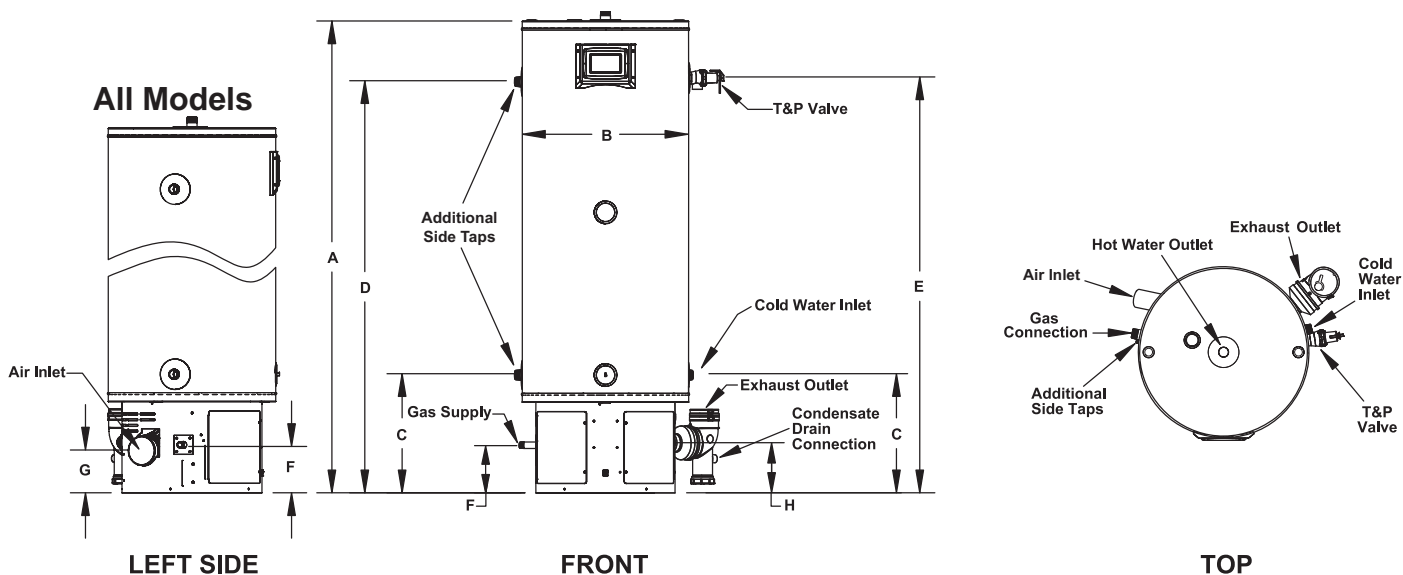


Figure 1. DIMENSIONS FOR ALL MODELS

Table 1A - ROUGH-IN-DIMENSIONS

U.S. GALLONS	INPUT (KBTU/HR)	UNITS	EXTERIOR		WATER CONNECTIONS		T&P HOT	GAS SUPPLY	AIR INLET/EXHAUST	
			A	B	C	D	E	F	G	H
34	100	Inches	48-1/2	22	15-3/4	40-1/2	41	6-3/8	5-1/2	6-5/8
		cm	123.19	55.88	40	102.87	104.14	16.19	13.97	16.82
34	130	Inches	48-1/2	22	15-3/4	40-1/2	41	6-3/8	5-1/2	6-5/8
		cm	123.19	55.88	40	102.87	104.14	16.19	13.97	16.82
34	150	Inches	48-1/2	22	15-3/4	40-1/2	41	6-3/8	5-1/2	6-5/8
		cm	123.19	55.88	40	102.87	104.14	16.19	13.97	16.82
50	130	Inches	62-3/8	22	15-3/4	54-1/2	55	6-3/8	5-1/2	6-5/8
		cm	165.7	55.88	40	138.43	139.7	16.19	13.97	16.82
50	150	Inches	63-3/4	22	15-3/4	55-3/4	56-1/4	6-3/8	5-1/2	6-5/8
		cm	161.925	55.88	40	141.605	142.875	16.19	13.97	16.82
50	175	Inches	63-3/4	22	15-3/4	55-3/4	56-1/4	6-3/8	5-1/2	6-5/8
		cm	161.925	55.88	40	141.605	142.875	16.19	13.97	16.82
50	199	Inches	63-3/4	22	15-3/4	55-3/4	56-1/4	6-3/8	5-1/2	6-5/8
		cm	161.925	55.88	40	141.605	142.875	16.19	13.97	16.82

Top Outlet: 1" NPT

Side Inlet: 1" NPT

Gas Inlet: 1/2" NPT

Condensate drain outlet: 1/2" NPT

Table 1B - ROUGH-IN-DIMENSIONS

U.S. GALLONS	INPUT (KBTU/HR)	VENT DIAMETER (in.)	APPROX SHIP. WEIGHT (lbs.)
34	100	2 OR 3	150
34	130	2 OR 3	150
34	150	2 OR 3	150
50	130	2 OR 3	176
50	150	2 OR 3	180
50	175	3	180
50	199	3	180



# DIMENSIONS AND CAPACITY DATA

**Table 2 – CAPACITY, GAS AND ELECTRICAL CHARACTERISTICS**

Approximate Capacity		*Manifold Pressure			Electrical Characteristics	
U.S. Gals.	Liters	Gas Type	"WC	kPA	Volts/Hz	Amperes
34	129	Nat./LP	0	0	120/60	<7
50	189	Nat/LP	0	0	120/60	<7

\*The manifold pressure is the factory setting and is not adjustable. A negative pressure will be seen with just the blower running without the Gas Control Valve open.

All models - Maximum Supply Pressure: 14 inches W.C. (3.48kPa)

Minimum Supply Pressure for Natural Gas: 3.50" (.87kPa)

Minimum Supply Pressure for Propane Gas: 8.00" (1.99kPa)

Minimum pressure must be maintained under both load and no load (dynamic and static) conditions.

**Table 3 – RECOVERY CAPACITIES**

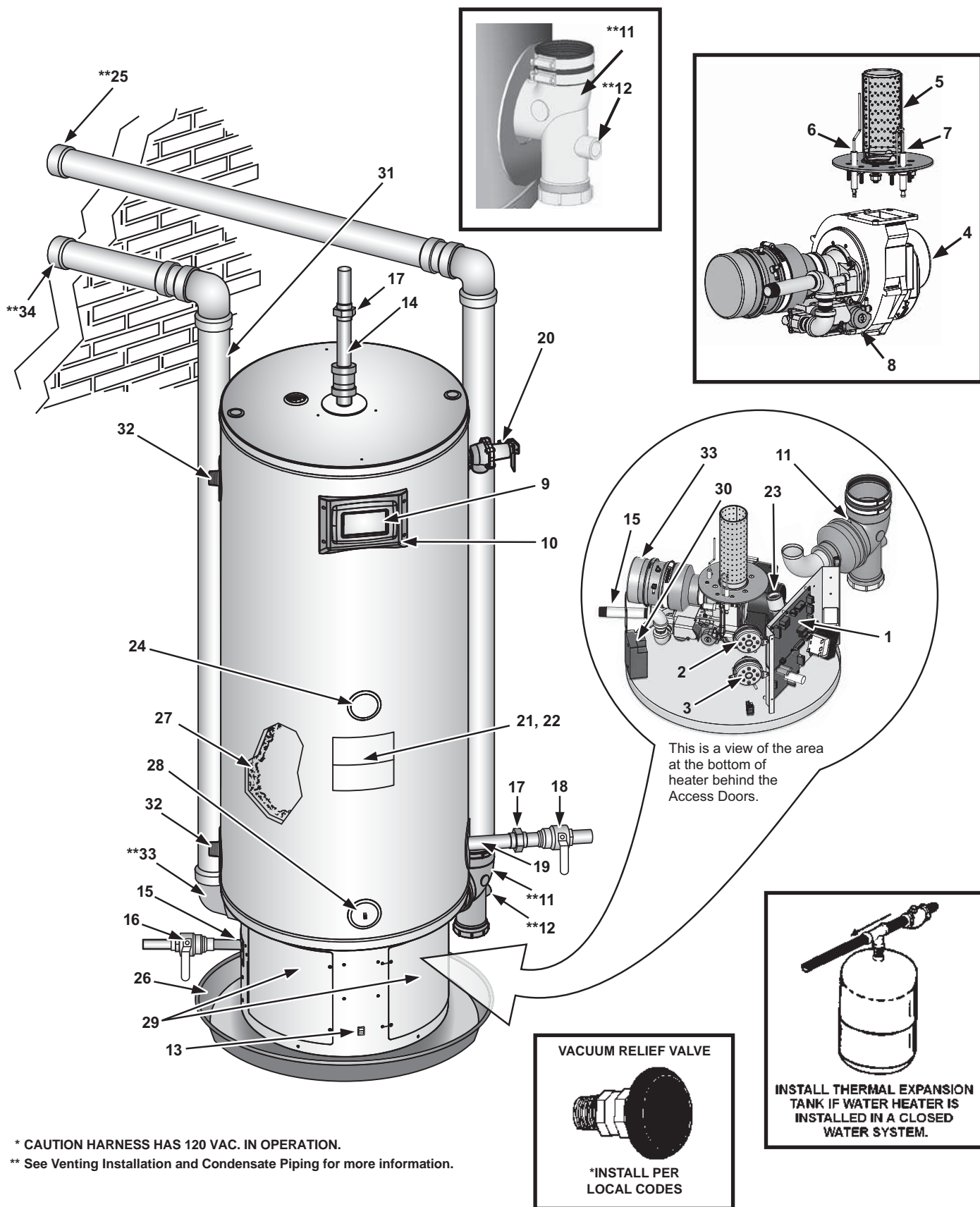
Input		Temp. Rise	Recovery Capacities												
Rating (Btu/hr)	Rating (kW)		F	30	40	50	60	70	80	90	100	110	120	130	140
			C	17	22	28	33	39	44	50	56	61	67	72	78
100,000	29.3	GPH		381	286	229	190	163	143	127	114	104	95	88	82
		LPH		1442	1082	865	721	618	541	481	433	393	361	333	309
130,000	38.1	GPH		495	371	297	248	212	186	165	149	135	124	114	106
		LPH		1875	1406	1125	937	803	703	625	562	511	469	433	402
150,000	44.0	GPH		571	429	343	286	245	214	190	171	156	143	132	122
		LPH		2163	1622	1298	1082	927	811	721	649	590	541	499	464
175,000	51.3	GPH		667	500	400	333	286	250	222	200	182	167	154	143
		LPH		2524	1893	1514	1262	1082	946	841	757	688	631	582	541
199,000	58.3	GPH		758	569	455	379	325	284	253	227	207	190	175	162
		LPH		2870	2152	1722	1435	1230	1076	957	861	783	717	662	615

Recovery capacity based on 95% thermal efficiency.



# FEATURES AND COMPONENTS (CONT.)

## 50 GALLON UNIT



\* CAUTION HARNESS HAS 120 VAC. IN OPERATION.  
 \*\* See Venting Installation and Condensate Piping for more information.

Figure 3. 50 GALLON UNIT

## FEATURES AND COMPONENTS (CONT.)

- 1: Control Assembly
- 2: Blocked Intake Switch
- 3: Blocked Outlet Switch
- 4: Blower Assembly
- 5: Burner Assembly
- 6: Flame Sensor
- 7: Igniter Assembly
- 8: Gas Control Valve Assembly
- 9: Display Board
- 10: Display Enclosure
- \*\* 11: Exhaust Elbow Assembly
- \*\* 12: Condensate Drain Outlet
- 13: Enable / Disable Switch
- 14: Hot Water Outlet
- 15: Gas Supply
- 16: Main Manual Gas Shutoff Valve
- 17: Union
- 18: Inlet Water Shutoff Valve
- 19: Cold Water Inlet
- 20: T & P Relief Valve
- 21: Rating Plate
- 22: Labels
- 23: Drain Valve
24. Upper Temperature Probe (ECO)
- \*\* 25: Exhaust Vent Terminal
- 26: Drain Pan
- 27: Insulation
- 28: Lower Temperature Probe
- 29: Access Door
- 30: Spark Module
31. Air Intake Pipe
32. Additional Side Taps
33. Intake Air Connection
- \*\*34. Intake Vent Terminal

## CONTROLS AND SWITCHES

This model is provided with two pressure switches. These switches are essential to the safe and proper operation of the unit. All switches are wired in series. The controller is set up to shut the unit down whenever there is a failure of any of the switches. It is important to understand the purpose of each switch.

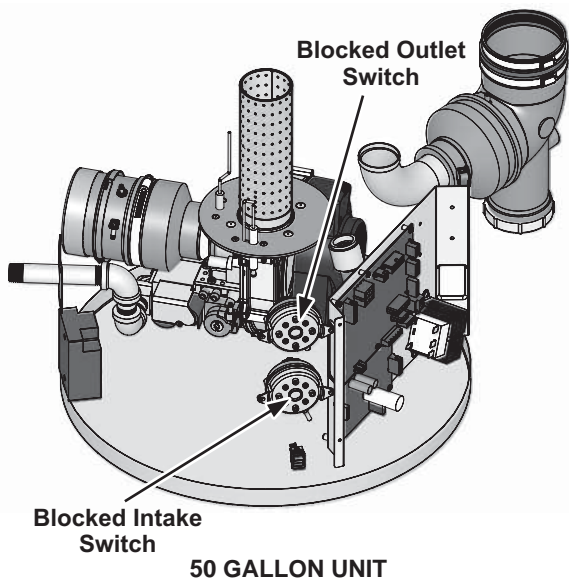
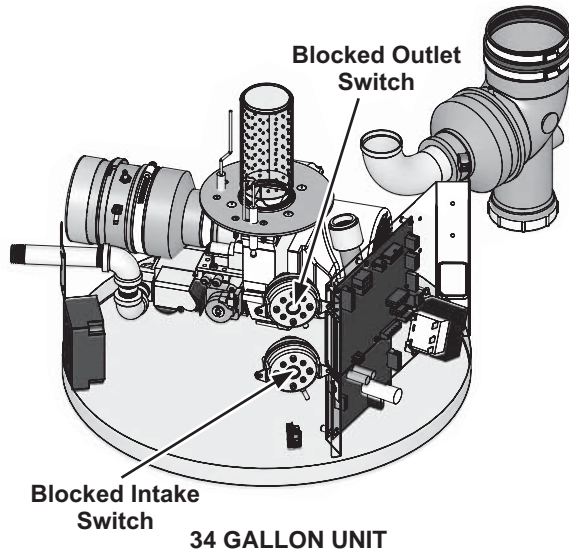


Figure 4

### BLOCKED OUTLET SWITCH

The Blocked Outlet Switch is set up to shut the unit off when a build-up of positive pressure in the exhaust vent pipe occurs. This switch is a positive pressure switch that requires an increase in pressure to change the electrical contacts from normally closed to open. When this switch prevents the unit from igniting, most likely the exhaust is blocked by some means. Check to see if the condensate is allowed to flow freely from the exhaust elbow and for obstructions in the exhaust venting and exhaust vent terminal. Also verify that the vent length does not exceed the maximum allowed as shown in Planning the Vent System beginning on page 22.

### BLOCKED INTAKE SWITCH

The Blocked Intake Switch is set up to shut the unit off when a build-up of negative pressure in the intake air pipe occurs. This switch is a negative pressure switch that requires an increase in negative pressure to change the electrical contacts from normally closed to open. The switch is connected to the pressure tap on the PVC pipe connected to the inlet of the blower. When this switch prevents the unit from igniting, most likely the intake is blocked. Verify that the integrated filter on the intake air connection, the intake air pipe, and the intake air termination are free of obstructions that may prevent air from entering the unit. Also Verify the intake air pipe length does not exceed the maximum allowed in Planning the Vent System beginning on page 22.

### WATER HEATING ENABLE/DISABLE SWITCH

**IMPORTANT:** The Enable/Disable switch listed in this manual is NOT an "on/off" switch and does not disconnect 120 volt power to the CCB and other heater components.

When in the "Disabled" position the switch removes electrical power from the gas control valve so that water heating is disabled. The display, CCB, and other electrical components will still be energized and the display will read "Water Heating Disabled".

### SPARK IGNITER

The Spark Igniter is a device that ignites the main burner by spark. When high voltage is applied to the igniter, spark is generated to ignite the main burner.

### CONFIGURATION KEY

The configuration key is located inside the control box. It provides for the ability of the heater to retain information collected over its lifetime, even if the control board is replaced because of failure.

The configuration key should stay with the heater.



# INSTALLATION CONSIDERATIONS

## LOCATING THE WATER HEATER

### CAUTION

#### Property Damage Hazard

- All water heaters eventually leak.
- Do not install without adequate drainage.

Carefully choose a location for the new water heater. The placement is a very important consideration for the safety of the occupants in the building and for the most economical use of the water heater.

Whether replacing an existing water heater or installing the water heater in a new location observe the following critical points:

1. The water heater must be located indoors.
2. The water heater must not be located in an area where it will be subject to freezing temperatures.
3. Locate the water heater so it is protected and not subject to physical damage by a moving vehicle. In garage installation avoid damage to your water heater by installing a vehicle stop as shown in Figure 5. Check state and local codes for requirements prior to installation.
4. Locate the water heater on a level surface.
5. Locate the water heater near a floor drain. The water heater should be located in an area where leakage of the tank or connections will not result in damage to the area adjacent to the water heater or to lower floors of the structure. When such locations cannot be avoided, it is recommended that a metal drain pan, piped to adequate drain, be installed under the water heater. Drain pan should be fabricated with sides at least 1-3/4" deep with diameter at least 2" greater than diameter of heater. Pan must not restrict combustion air flow.
6. Locate the water heater close to the point of major hot water usage.
7. Locate the water heater close to a 120 VAC power supply. See Power Supply on Page 16 for requirements.
8. Locate the water heater where an adequate supply of fresh air for combustion and ventilation can be obtained. See Combustion Air and Ventilation on Page 15.
9. Locate the water heater where the vent and intake air piping, when installed, will remain within the maximum equivalent lengths allowed. See Planning the Vent System on page 22.

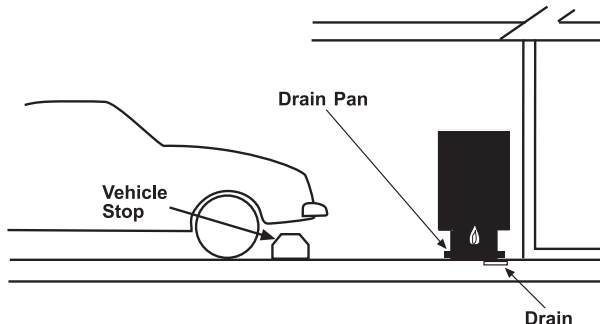


Figure 5. GARAGE INSTALLATION

11. Do not locate the water heater where the subsequent installation of the vent (exhaust) or intake air terminations would be objectionable due to noise at the termination(s). This includes locations close to or across from windows and doors. See Venting Installation beginning on page 14.

### WARNING

#### Fire or Explosion Hazard

- Do not store or use gasoline or other flammable vapors and liquids in the vicinity of this or any other appliance.
- Avoid all ignition sources if you smell LP gas.
- Do not expose water heater control to excessive gas pressure.
- Use only gas shown on rating plate.
- Maintain required clearances to combustibles.
- Keep ignition sources away from faucets after extended period of non-use.



Read instruction manual before installing, using or servicing water heater.



Do not locate water heater areas where flammable liquids (vapors) are likely to be present or stored (garages, storage and utility areas, etc.): Flammable liquids (such as gasoline, solvents, propane (LP or butane, etc.) and other substances (such as adhesives, etc.) emit flammable vapors which can be ignited by a gas water heater's ignition device or main burner. The resulting flashback and fire can cause death or serious burns to anyone in the area.

### DANGER



**⚠ Vapors from flammable liquids may explode and catch fire causing death or severe burns.**

Do not use or store flammable products such as gasoline, solvents or adhesives in the same room or area near the water heater.

Keep flammable products:

1. far away from heater,
2. in approved containers,
3. tightly closed and
4. out of children's reach.

Water heater has a main burner and ignition device  
The ignition device:

1. can come on at any time and
2. will ignite flammable vapors.

Vapors:

1. cannot be seen,
2. are heavier than air,
3. go a long way on the floor and
4. can be carried from other rooms to the ignition device by air currents.

When the water heater is installed directly on carpeting, the water heater shall be installed on a metal or wood panel extending beyond the full width and depth of the water heater by at least 3" (7.62 cm) in any direction or, if the water heater is installed in an alcove or closet, the entire floor shall be covered by the panel. The panel must be strong enough to carry the weight of the heater when full of water.

10. Do not locate the water heater where noise (such as the Combustion Blower) during normal operation will be objectionable in adjacent areas.



**⚠ WARNING**  
**Fire or Explosion Hazard**

Read instruction manual before installing, using or servicing water heater.

- Improper use may result in fire or explosion.
- Maintain required clearances to combustibles.

Minimum clearances from combustible materials are stated on the data plate located on the front of the water heater. Standard clearances are 0" (0 cm) at the sides and rear, 0" (0 cm) from the front, and 0" (0 cm) from the top. If the clearances from combustible material stated on the water heater differ from the standard clearances, install the water heater according to the clearances stated on the water heater.

Adequate clearance for inspection and service should be considered before installation. A minimum of 24" (61 cm) of front clearance and 4" (10.2 cm) on each side should be provided for access to replaceable and/or serviceable parts such as thermostats, drain valve, condensate drain, temperature-pressure relief valve, and the vent connection (exhaust elbow).

Figure 6 may be used as a reference guide to locate the specific clearance locations. When installing the water heater, consideration must be given to proper location. The location selected should be as close to the wall as practicable and as centralized with the water piping system as possible.

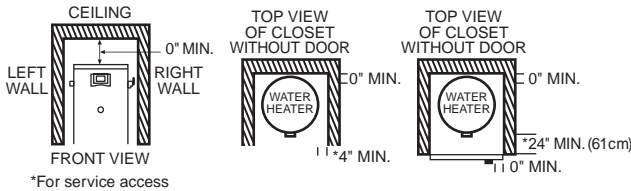


Figure 6: MINIMUM CLEARANCE LOCATIONS

**INSULATION BLANKETS**

**⚠ WARNING**  
**Breathing Hazard - Carbon Monoxide Gas**

- Do not obstruct water heater air intake with insulating blanket.
- Gas and carbon monoxide detectors are available.
- Install water heater in accordance with the instruction manual.

Breathing carbon monoxide can cause brain damage or death. Always read and understand instruction manual.

Insulation blankets are available to the general public for external use on gas water heaters but are not necessary with these products. The purpose of an insulation blanket is to reduce the standby heat loss encountered with storage tank heaters. Your water heater meets or exceeds the Energy Policy Act standards with respect to insulation and standby loss requirements, making an insulation blanket unnecessary.

Should you choose to apply an insulation blanket to this heater, you should follow these instructions (For identification of components mentioned below. See Figures 1, 2, 3 and 4. Failure to follow these instructions can restrict the air flow required for proper combustion, potentially resulting in fire, asphyxiation, serious personal injury or death.

- Do not cover the control system LCD on top of the water heater.
- Do not cover the outer door, thermostat or temperature-pressure relief valve.
- Do not cover the instruction manual. Keep it on the side of the water heater or nearby for future reference.

- Do obtain new warning and instruction labels from the manufacturer for placement on the blanket directly over the existing labels.
- Do inspect the insulation blanket frequently to make certain it does not sag, thereby obstructing combustion air flow.

**COMBUSTION AIR AND VENTILATION**

A gas water heater cannot operate properly without the correct amount of air for combustion. Never obstruct the flow of ventilation air. If you have any doubts or questions at all, call your gas supplier. Failure to provide the proper amount of combustion air can result in a fire or explosion and cause death, serious bodily injury, or property damage.

**⚠ WARNING**  
**Breathing Hazard - Carbon Monoxide Gas**

- Install water heater in accordance with the instruction manual and CAN/CSA-B149.1
- To avoid injury, combustion and ventilation air must be taken from outdoors.
- Do not place chemical vapor emitting products near water heater.

Breathing carbon monoxide can cause brain damage or death. Always read and understand instruction manual.

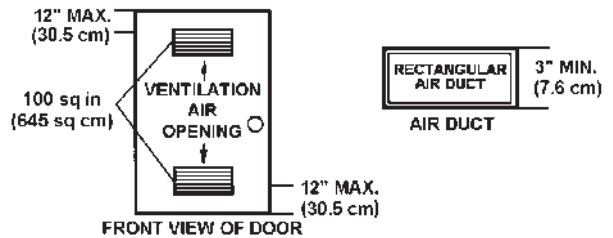


Figure 7: COMBUSTION AIR AND VENTILATION

It is imperative that the water heater(s) be installed direct vent so that all air for combustion and ventilation is taken from outdoors.

Propellants of aerosol sprays and volatile compounds, (cleaners, chlorine based chemicals, refrigerants, etc.) in addition to being highly flammable in many cases, will also react to form corrosive acids when exposed to the combustion products of the water heater. The results can be hazardous, and also cause product failure. Air for combustion and ventilation must not come from a corrosive atmosphere. Any failure due to corrosive elements in the atmosphere is excluded from warranty coverage.

**CORROSION AND WATER QUALITY**

Water quality will vary from location to location and may contain contaminants that may reduce the life or performance of the water heater.

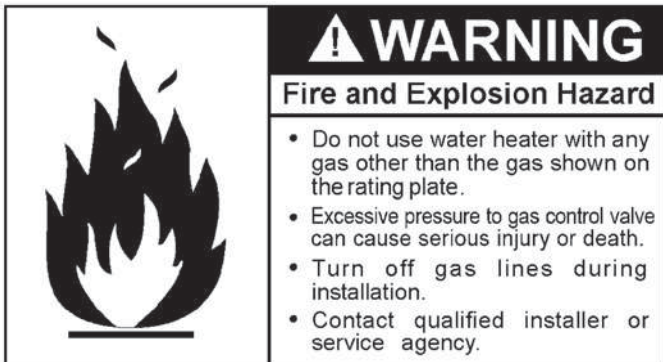
Contaminates which can reduce the life or performance of the water heater if present in high quantities include those which contribute to hardness (dissolved minerals such as sodium, calcium and magnesium); plus chlorides and sulfates. Additionally, water that is too acidic or basic (measured as pH) can reduce the life of the water heater. Water treatment systems (such as water softeners for hardness) should be used and maintained properly if the contaminate levels exceed the following:

**Warranty is void in applications which exceed the water quality requirements listed below.**

Total Hardness:	12 grains per gal. (205 mg/liter) max.
Chloride:	200 mg/liter max.
pH:	6.5-8.0
Alkalinity:	200 mg/liter max.

# INSTALLATION REQUIREMENTS

## GAS SUPPLY SYSTEMS



Low pressure building gas supply systems are defined as those systems that cannot under any circumstances exceed 14" W.C. (1/2 PSI Gauge). These systems do not require pressure regulation. Measurements should be taken to insure that gas pressures are stable and fall within the requirements stated on the water heater rating plate. Readings should be taken with all gas burning equipment off (static pressure) and with all gas burning equipment running at maximum rate (dynamic pressure). The gas supply pressure must be stable within 1.5" W.C. from static to dynamic pressure to provide good performance. Pressure drops that exceed 1.5" W.C. may cause rough starting, noisy combustion or nuisance outages. Increases or spikes in static pressure during off cycles may cause failure to ignite or in severe cases damage to water heater gas control valves. If your low pressure system does NOT meet these requirements, the installer is responsible for the corrections.

High pressure building supply systems use pressures that exceed 14" W.C. (1/2 PSI Gauge). These systems must use field supplied regulators to lower the gas pressure to less than 14" W.C. (1/2 PSI Gauge). Water heaters require gas regulators that are properly sized for the water heater input and deliver the rating plate specified pressures. Gas supply systems where pressure exceeds 5 PSI often require multiple regulators to achieve desired pressures. Systems in excess of 5 PSI building pressure should be designed by gas delivery professionals for best performance. Water heaters connected to gas supply systems that exceed 14" W.C. (1/2 PSI Gauge) at any time must be equipped with a gas supply regulator.

All models require a minimum gas supply pressure of 3.5" W.C.(0.87 kPa) for natural gas and 8.0" W.C. (1.99 kPa) for propane. The minimum supply pressure is measured while gas is not flowing (static pressure) AND while gas is flowing (dynamic pressure). The supply pressure (static and dynamic) should never fall below 3.5" W.C.(0.87 kPa) for natural gas or 8.0" W.C. (1.99 kPa) for propane. The supply pressure should be measured with all gas fired water heaters connected to the common main firing at full capacity. If the supply pressure drops more than 1.5" W.C. (0.37 kPa) as gas begins to flow to the water heater then the supply gas system including the gas line and/or the gas regulator may be restricted or undersized. See Supply Gas Regulator on page 16 and Supply Gas Line Installation on page 30. The gas control valve on all models has a maximum gas supply pressure limit of 14" W.C.(3.48 kPa) The maximum supply pressure is measured while gas is not flowing (static pressure) AND while gas is flowing (dynamic pressure).

## SUPPLY GAS REGULATOR

The maximum allowable gas supply pressure for this water heater is 14 inches W.C. (3.5 kPa). Install a positive lock-up gas pressure regulator in the gas supply line if inlet gas pressure can exceed 14 inches W.C. (3.5 kPa) at any time. Regulators must be sized/used according to manufacturer's specifications.

If a positive lock-up regulator is required follow these instructions:

1. Positive lock-up gas pressure regulators must be rated at or above the input Btu/hr rating of the water heater they supply.
2. Supply gas regulators shall have inlet and outlet connections not less than the minimum supply gas line size for the water heater they supply
3. Positive lock-up gas pressure regulator(s) should be installed no closer than 3 feet (1 meter) and no farther than 8 feet (2.4 meters) from the water heater's inlet gas connection.
4. After installing the positive lock-up gas pressure regulator(s) an initial nominal supply pressure setting of 7.0" W.C.(1.74 kPa) for Natural Gas and 11.0" W.C. (2.74 kPa) for Propane (LP) while the water heater is operating is recommended and will generally provide good water heater operation. Some additional adjustment may be required later to maintain a steady gas supply pressure.
5. When installing multiple water heaters in the same gas supply system it is recommended that individual positive lock-up gas pressure regulators be installed at each unit.

All gas piping must comply with local codes and ordinances or with current editions of the Natural Gas and Propane Installation Code CAN/CSA B149.1. Copper or brass tubing and fittings (except tin lined copper tubing) shall not be used.

If the gas control valve is subjected to pressures exceeding 1/2 psi (3.5 kPa), the damage to the gas control valve could result in a fire or explosion from leaking gas.

If the main gas line Shut-off serving all gas water heaters is used, also turn off the gas at each water heater. Leave all gas appliances shut off until the water heater installation is complete.

A gas line of sufficient size must be run to the water heater. Consult the current edition of the Natural Gas and Propane Installation Code CAN/CSA B149.1. and your gas supplier concerning pipe size.

There must be:

- A readily accessible manual shut off valve in the gas supply line serving the water heater, and
- A sediment trap ahead of the gas control valve to help prevent dirt and foreign materials from entering the gas control valve.
- A ground joint union of proper size between the manual shut off valve and gas control valve to permit servicing of the unit.

Be sure to check all the gas piping for leaks before lighting the water heater. Use a soapy water solution, not a match or open flame. Rinse off soapy solution and wipe dry.

## POWER SUPPLY

The water heaters covered in this manual require a 120 VAC, 1Ø (single phase), 60Hz, 7 amp power supply and must also be electrically grounded in accordance with local codes or, in the absence of local codes, with the Canadian Electrical Code, CSA C22.1.

If any of the original wire as supplied with the water heater must be replaced, it must be replaced with 105°C rated wiring or its equivalent, except in the burner housing. In this case 200°C rated wire must be used.

## DEDICATED POWER WIRING AND BREAKERS

Dedicated power supply wires, ground wiring and dedicated circuit breakers often prevent electrical line noise and should be considered when installing the water heater.

## POWER FLUCTUATIONS AND ELECTRICAL NOISE

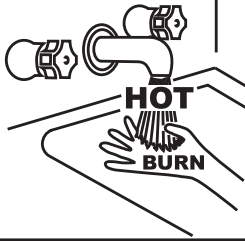
The water heater's control system requires a source of stable clean electricity for proper operation. Connecting the water heater to a branch circuit that is subject to fluctuations in voltage level

or electrical line noise such as EMI (electro magnetic interference) or RFI (radio frequency interference) may cause erratic control system operation and malfunction.

A high quality power supply filter/suppressor must be installed if the above conditions exist. Call the technical support phone number for more information.

**NOTE:** Malfunctions caused by the power supply and the costs to install the power supply filters are not covered under the limited warranty.

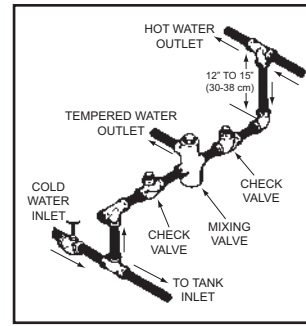
**MIXING VALVES**

	<p><b>⚠ DANGER</b> Water temperature over 125°F (52°C) can cause severe burns instantly resulting in severe injury or death.</p> <p>Children, the elderly and the physically or mentally disabled are at highest risk for scald injury.</p> <p>Feel water before bathing or showering.</p> <p>Temperature limiting devices such as mixing valves must be installed when required by codes and to ensure safe temperatures at fixtures.</p>
---	--

Water heated to a temperature which will satisfy clothes washing, dish washing, and other sanitizing needs can scald and cause permanent injury upon contact. Short repeated heating cycles caused by small hot water uses can cause temperatures at the point of use to exceed the water heater's temperature setting by up to 20°F (11°C).

Some people are more likely to be permanently injured by hot water than others. These include the elderly, children, the infirm and the physically/mentally disabled. Table 4 shows the approximate time-to-burn relationship for normal adult skin. If anyone using hot water provided by the water heater being installed fits into one of these groups or if there is a local code or state law requiring a certain water temperature at the point of use, then special precautions must be taken.

In addition to using the lowest possible temperature setting that satisfies the demand of the application a Mixing Valve should be installed at the water heater or at the hot water taps to further reduce system water temperature. See Figure 8 below and Figures 52 through 54 in Piping Diagrams beginning on Page 58.



**Figure 8**

Mixing valves are available at plumbing supply stores. Consult a Qualified Installer or Service Agency. Follow mixing valve manufacturer's instructions for installation of the valves.

In all cases, the following burn table must be used.

**Table 4**

Water Temperature °F (°C)	Time for 1st Degree Burn (Less Severe Burns)	Time for Permanent Burns 2nd & 3rd Degree (Most Severe Burns)
110 (43.3)	(normal shower temp.)	
116 (46.7)	(pain threshold)	
116 (46.7)	35 minutes	45 minutes
122 (50)	1 minute	5 minutes
131 (55)	5 seconds	25 seconds
140 (60)	2 seconds	5 seconds
149 (65)	1 second	2 seconds
154 (67.8)	instantaneous	1 second

(U.S. Government Memorandum, C.P.S.C., Peter L. Armstrong, Sept. 15, 1978)

**CIRCULATION PUMPS**

A circulating pump is used when a system requires a circulating loop or there is a storage tank used in conjunction with the water heater. The tank is provided with a 1" NPT recirculation loop return connection. See the Piping Diagrams section beginning on Page 59 for the installation location of circulating pumps.

See Circulation Pump Wiring Diagrams on page 58 for electrical hookup information. Install in accordance with the current edition of Canadian Electrical Code, CSA C22.1.

Refer to the circulating pump manufacturer's instructions for its operation, lubrication and maintenance instructions.

## SPACE HEATING AND POTABLE WATER SYSTEM

Your water heater is equipped with additional side taps for use in space heating applications. See Features and Components on Page 10 for locations. If this water heater is to be used to supply both space heating and potable (drinking) water, the instructions listed below must be followed:

- Be sure to follow the manual(s) shipped with the air handler or other type heating system.
- This water heater cannot be used in space heating applications only.
- This water heater is not to be used as a replacement for an existing boiler installation.
- Do not use with piping that has been treated with chromates, boiler seal or other chemicals and do not add any chemicals to the water heater piping
- If the space heating system requires water temperatures in excess of 120°F, a mixing valve must be installed per the manufacturer's instructions in the potable hot water supply to limit the risk of scald injury. See Mixing Valves on Page 17.
- Pumps, valves, piping and fittings must be compatible with potable water.
- A properly installed flow control valve is required to prevent thermosiphoning. Thermosiphoning is the result of a continuous flow of water through the air handler circuit during the off cycle. Weeping (blow off) of the temperature-pressure relief valve (T & P relief valve) or higher than normal water temperatures are the first signs of thermosiphoning.
- The hot water line from the water heater should be vertical past any mixing valve or supply line to the heating system to remove air bubbles from the system. Do not connect the water heater to any system or components previously used with non-potable water heating appliances when used to supply potable water.

## STORAGE TANK INSTALLATION

When installing the water heater with a storage tank, see Figure 54 on page 59 in Piping Diagrams for suggestions.

**NOTE:** If tank temperature is set above 120°F and water is supplied for domestic use (hand washing, showering, etc.) a mixing valve should be installed in the hot water line to domestic fixtures. Installation must conform to local code requirements. If a check valve is installed in the cold water supply line, an expansion tank must be installed between the check valve and the water heater's cold water inlet. Set storage tank temperature five degrees lower than the water heater's temperature setting. Using the plug valve, adjust the flow in the recirculating line to five gallons per minute.

## SOLAR INSTALLATION

If this water heater is used as a solar storage heater or as a backup for the solar system, the water supply temperatures to the water heater tank may be in excess of 120°F (48.9°C). A mixing valve must be installed in the water supply line to limit the supply temperature to 120°F (48.9°C).

**NOTE:** Solar water heating systems can often supply water with temperatures exceeding 180°F (82.2°C) and may result in water heater malfunction.

## CLOSED WATER SYSTEMS

Water supply systems may, because of code requirements or such conditions as high line pressure, among others, have installed

devices such as pressure reducing valves, check valves, and back flow preventers. Devices such as these cause the water system to be a closed system.

## THERMAL EXPANSION

As water is heated, it expands (thermal expansion). In a closed system the volume of water will grow when it is heated. As the volume of water grows there will be a corresponding increase in water pressure due to thermal expansion. Thermal expansion can cause premature tank failure (leakage). This type of failure is not covered under the limited warranty. Thermal expansion can also cause intermittent temperature-pressure relief valve operation: water discharged from the valve due to excessive pressure build up. This condition is not covered under the limited warranty. The temperature-pressure relief valve is not intended for the constant relief of thermal expansion.

A properly sized thermal expansion tank should be installed on all closed systems to control the harmful effects of thermal expansion. Contact a local plumbing service agency to have a thermal expansion tank installed.

<b>CAUTION</b>	
<b>Property Damage Hazard</b>	
<ul style="list-style-type: none"><li>• Avoid water heater damage.</li><li>• Install thermal expansion tank if necessary.</li><li>• Do not apply heat to cold water inlet.</li><li>• Contact qualified installer or service agency.</li></ul>	

**NOTE:** To protect against untimely corrosion of hot and cold water fittings, it is strongly recommended that di-electric unions or couplings be installed on this water heater (see Figure 9) when connected to copper pipe.

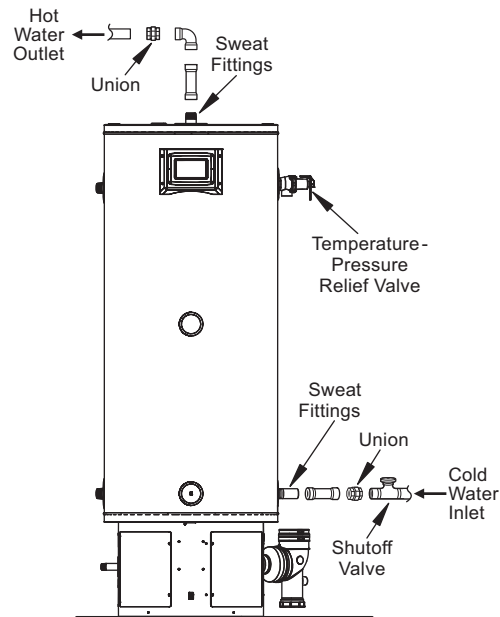


Figure 9

Figure 9 also shows the typical attachment of the water piping to the water heater. The water heater is equipped with 1" NPT



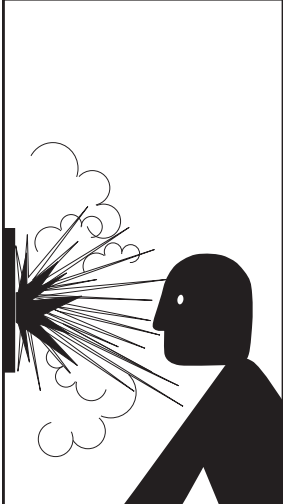
connections for all models.

**NOTE:** If using copper tubing, solder tubing to an adapter before attaching the adapter to the water heater connections. Do not solder the water lines directly to the water heater connections. It will damage the tank, T & P Valve and Pipe Insulation (if supplied).

Fit pipe insulation over the incoming cold water line and the hot water line. Make sure that the insulation is against the top cover of the heater. Fit T & P valve insulation over valve. Make sure that the insulation does not interfere with the lever of the T & P valve.

Secure all insulation using tape.

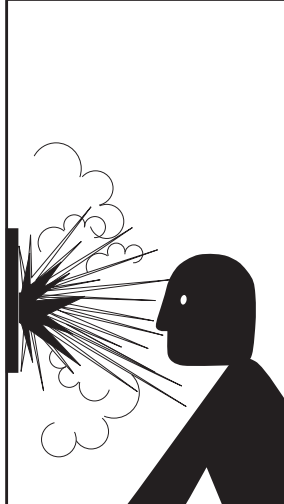
### TEMPERATURE-PRESSURE RELIEF VALVE

	<b>⚠ WARNING</b>
	<b>Explosion Hazard</b>
	<ul style="list-style-type: none"><li>• Temperature-Pressure Relief Valve must comply with ANSI Z21.22- CSA 4.4 and ASME code.</li><li>• Properly sized temperature-pressure relief valve must be installed in opening provided.</li><li>• Can result in overheating and excessive tank pressure.</li><li>• Can cause serious injury or death.</li></ul>

This water heater is provided with a properly rated/sized and certified combination Temperature-Pressure Relief Valve (T&P relief valve) by the manufacturer. The valve is certified by a nationally recognized testing laboratory that maintains periodic inspection of production of listed equipment of materials as meeting the requirements for Relief Valves for Hot Water Supply Systems, ANSI Z21.22 • CSA 4.4, and the code requirements of ASME.

If replaced, the new T&P valve must meet the requirements of local codes, but not less than a combination Temperature-Pressure Relief Valve rated/sized and certified as indicated in the previous paragraph. The new valve must be marked with a maximum set pressure not to exceed the marked hydrostatic working pressure of the water heater (150 psi = 1,035 kPa) and a discharge capacity not less than the water heater Btu/hr or kW input rate as shown on the water heater's model rating plate.

**NOTE:** In addition to the factory installed Temperature-Pressure Relief Valve on the water heater, each remote storage tank that may be installed and piped to a water heating appliance must also have its own properly sized, rated and approved Temperature-Pressure Relief Valve installed.

	<b>⚠ WARNING</b>
	<b>Explosion Hazard</b>
	<ul style="list-style-type: none"><li>• Temperature-Pressure Relief Valve must comply with ANSI Z21.22- CSA 4.4 and ASME code.</li><li>• Properly sized temperature-pressure relief valve must be installed in opening provided.</li><li>• Can result in overheating and excessive tank pressure.</li><li>• Can cause serious injury or death.</li></ul>

For safe operation of the water heater, the Temperature-Pressure Relief Valve must not be removed from its designated opening nor plugged. The Temperature-Pressure Relief Valve must be installed directly into the fitting of the water heater designed for the Temperature-Pressure Relief Valve. Install discharge piping so that any discharge will exit the pipe within 12 inches (30.5 cm) above an adequate floor drain, or external to the building. In cold climates it is recommended that it be terminated at an adequate drain inside the building. Be certain that no contact is made with any live electrical part. The discharge opening must not be blocked or reduced in size under any circumstances. Excessive length, over 30 feet (9.14 m), or use of more than four elbows can cause restriction and reduce the discharge capacity of the valve.

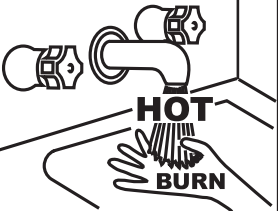
No valve or other obstruction is to be placed between the Temperature-Pressure Relief Valve and the tank. Do not connect discharge piping directly to the drain unless a 12" (30.5 cm) air gap is provided. To prevent bodily injury, hazard to life, or property damage, the temperature-pressure relief valve must be allowed to discharge water in adequate quantities should circumstances demand. If the discharge pipe is not connected to a drain or other suitable means, the water flow may cause property damage.

<b>CAUTION</b>
<b>Water Damage Hazard</b>
<ul style="list-style-type: none"><li>• Temperature-Pressure Relief Valve discharge pipe must terminate at adequate drain.</li></ul>

#### T&P VALVE DISCHARGE PIPE REQUIREMENTS:

- Shall not be smaller in size than the outlet pipe size of the valve, or have any reducing couplings or other restrictions.
- Shall not be plugged or blocked.
- Shall not be exposed to freezing temperatures.

- Shall be of material listed for hot water distribution.
- Shall be installed so as to allow complete drainage of both the Temperature-Pressure Relief Valve and the discharge pipe.
- Must terminate a maximum of 12 inches (30.5 cm) above a floor drain or external to the building. In cold climates, it is recommended that the discharge pipe be terminated at an adequate drain inside the building.
- Shall not have any valve or other obstruction between the temperature-pressure relief valve and the drain.



**⚠ DANGER**

- Burn hazard.
- Hot water discharge.
- Keep clear of Temperature-Pressure Relief Valve discharge outlet.

The Temperature-Pressure Relief Valve must be manually operated at least twice a year. Caution should be taken to ensure that (1) no one is in front of or around the outlet of the Temperature-Pressure Relief Valve discharge line, and (2) the water manually discharged will not cause any bodily injury or property damage because the water may be extremely hot. If after manually operating the valve, it fails to completely reset and continues to release water, immediately close the cold water inlet to the water heater, follow the draining instructions in this manual, and replace the Temperature-Pressure Relief Valve with a properly rated/sized new one.

**NOTE:** The purpose of a Temperature-Pressure Relief Valve is to prevent excessive temperatures and pressures in the storage tank. The T&P valve is not intended for the constant relief of thermal expansion. A properly sized thermal expansion tank must be installed on all closed systems to control thermal expansion, see Closed Water Systems and Thermal Expansion on Page 18.

If you do not understand these instructions or have any questions regarding the Temperature-Pressure Relief Valve call the toll free number listed on the back cover of this manual for technical assistance.

## CONDENSATE DRAIN

The water heaters covered in this manual are condensing water heaters and require a building drain to be located in close proximity to allow the condensate to drain safely.

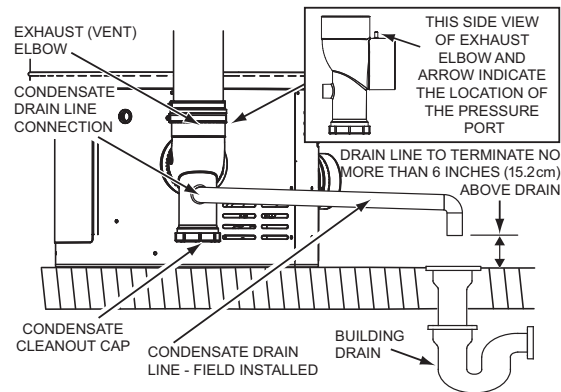
Condensate drains from the water heater at the exhaust elbow located at the bottom. The field installed condensate drain line must not be elevated above the condensate drain connection on the condensate trap, see Figure 10. If the condensate does not drain properly it will build up in the exhaust (vent) elbow. This will restrict the flow of flue gases and cause the Blocked Exhaust pressure switch to open its contacts. The control system monitors all pressure switches, if the Blocked Exhaust Switch contacts are open the control system will lock out and disable heating operation. The "Blocked Exhaust" Fault message will be displayed on the control system's LCD.

The Condensate Cleanout Cap must be on and tight when unit is in operation.

**NOTE:** If the "Blocked Exhaust " Fault message is ever displayed on the control system LCD, check the condensate drain first and ensure it is not blocked.

⚠ WARNING

Old trap piping is not compatible with new trap piping.



**Figure 10**

**DO NOT** remove the factory installed exhaust/condensate elbow for any reason, see Figure 10. The water heater's vent pipe is under a slight positive pressure while unit is in operation. The water trap inside of the exhaust/condensate elbow prevents flue gases from escaping into the installed space.

Do not install any external condensate trap. The exhaust elbow assembly has an internal condensate trap.

Installation must conform with these instructions and local building codes.

Field supplied materials required for installation include:


- Approved PVC cement and PVC primer.
- 1/2 inch PVC pipe - minimum length to equal the distance between the water heater and a suitable building drain.
- 1/2 inch PVC fittings (elbows, couplings, and adapters) necessary to install a condensate drain line between the Exhaust/Condensate Elbow Assembly and a suitable building drain.
- Floor mounted standoffs to brace the drain line.

### NOTES:


1. The condensate drains from the water heaters covered by this instruction have PH levels between 4.3 and 5.0. Install a commercially available neutralizing kit if required by local codes. Lower PH levels are acidic. Do not connect a metal condensate drain line, such as copper pipe, to the water heater for this reason.
2. The field installed condensate drain line must not be less than 1/2 inch PVC in size.
3. **DO NOT** remove, modify or alter the factory condensate trap.



# VENTING INSTALLATION

**WARNING**

**Breathing Hazard - Carbon Monoxide Gas**



- Install vent system in accordance with these instructions and local codes.
- Do not operate water heater if flood damaged.
- Do not operate if soot buildup.
- Do not obstruct water heater air intake with insulating jacket.
- Do not place chemical vapor emitting products near water heater.
- Gas and carbon monoxide detectors are available.
- Never operate the heater unless it is vented to the outdoors and has adequate air supply to avoid risks of improper operation, fire, explosion or asphyxiation.
- Analyze the entire vent system to make sure that condensate will not become trapped in a section of vent pipe and therefore reduce the open cross sectional area of the vent.

Breathing carbon monoxide can cause brain damage or death.  
Always read and understand instruction manual.

## VENT INSTALLATION CONSIDERATIONS

This water heater has a direct vent system in which all air for combustion is taken from the outside atmosphere and all combustion products are discharged to the outdoors.

This water heater must be properly vented for removal of exhaust gases to the outside atmosphere. Correct installation of the vent pipe system is mandatory for the safe and efficient operation of this water heater and is an important factor in the life of the unit.

Vent pipe installation must be performed in accordance with state and local codes, or in the absence of such, the Natural Gas Propane Installation Code CAN/CSA B149.1, current edition.

Either 2 inch or 3 inch pipe may be used on the vent termination for 100,000, 130,000 & 150,000 Btu/hr models. When concentric venting 100,000, 130,000 & 150,000 Btu/hr, use only 2 inch concentric vent on the vent termination. When concentric venting 100,000, 130,000 & 150,000 Btu/hr models, 3 inch pipe must be reduced to 2 inch concentric vent at the termination. Use only 3 inch pipe or 3 inch concentric vent on the vent termination for 175,000 & 199,000 Btu/hr models.

When replacing an existing Polaris unit, it is recommended that the venting system be reviewed for compliance with the requirements contained in this instruction manual. If the venting is not in compliance, it is recommended that the appropriate changes be made to bring it into compliance. Never operate the water heater unless it is vented to the outdoors.

**Note:** It is important that the factory-installed air inlet filter be inspected periodically and cleaned if necessary. See Integrated Filter Preventative Maintenance on Page 53 in the Periodic Maintenance section.

**Note:** If vent system is not in compliance with the current installation manual, the manufacturer reserves the right to evaluate installation prior to granting any warranty on service claims.

**Important:** Check to make sure the vent pipe is not blocked in any way.

**Note:** Do not common vent this water heater with any other appliance. Do not install in the same chase or chimney with a metal or high-temperature plastic from another gas or fuel burning appliance.

In cold climates any water vapor remaining in the flue gases will condense into a cloud of vapor at the point where the vent system exits the building. Special consideration is recommended,

before locating the vent termination near walkways, windows and building entrances.

Direct venting into dead spaces such as alleys, atriums, and inside corners can cause recirculation of flue gases. Recirculation of flue gases will cause sooting, and icing of the combustion air intake during severe cold weather. To prevent the recirculation of flue gases, maintain as much distance as possible between the combustion air intake and the exhaust vent terminal. Refer to Horizontal Vent Terminal Installation on Page 24 and Vertical Vent Terminal Installation on Page 25.

## GENERAL VENTING INSTRUCTIONS

The following guidelines should be followed when installing the air inlet and exhaust outlet piping:

- Venting should be as direct as possible with a minimum number of pipe fittings.
- Vent diameter must not be reduced unless specifically noted in the installation instructions.
- All 2" horizontal inlet vent piping must be sloped downward 1/4 inch per foot (3" Piping must slope downward 1/8" per foot) toward the water heater so that moisture in the inlet air will exit through the air intake moisture drain trap.
- All 2" horizontal exhaust vent piping must be sloped upward 1/4 inch per foot (3" Piping must slope upward at 1/8" per foot) so that condensate will run back to the heater and exit through the condensate trap.
- Support all horizontal pipe runs every four feet and all vertical pipe runs every six feet or according to local codes.
- All venting systems (except Polypropylene vent systems) run through unconditioned spaces where below freezing temperatures are expected should be properly insulated to prevent freezing. For horizontal runs, wrap the vent pipe with nationally recognized/listed heat tape and/or approved insulation for freeze protection. Install per the manufacturer's instructions.
- An air intake filter is included with the unit and must be installed according to the installation instructions supplied with the filter.
- It is important to select the proper pipe cement for the type of plastic pipe being used. All joints in the vent system piping (except Polypropylene vent systems) must be properly cemented. Polypropylene vent systems do not use cement to connect the pipe and elbow sections but use a push together gasket seal method. Do not attempt to connect Polypropylene with sealant cement.
- Piping must be sized and cut before cementing. Cut the pipe end square and remove all ragged edges and burrs. Make sure the inside of the pipe is clean and free of cuttings and loose dirt. Chamfer the end and apply primer to the fitting and pipe. Apply a moderate even coat of pipe cement inside the fitting. Apply a liberal amount of cement to the outside of the pipe to socket depth. Assemble the parts quickly while cement is still wet. Twist the pipe 1/4 turn during insertion and hold for 30 seconds.
- All pipe, fittings, pipe cement, primers and procedures must conform to American National Standard Institute and American Society for Testing and Materials (ANSI/ASTM) standards in the United States. This water heater has been design certified by the Canadian Standards Association for use with the specified (CSA) listed plastic vent pipe.

## APPROVED VENT/INTAKE MATERIAL

Approved vent pipe materials that must be used in Canada:

- ULC S636 PVC / CPVC
- ULC S636 Polypropylene - See Polypropylene Installations.

Approved intake air pipe materials that must be used in Canada:

PVC pipe materials:

- DWV ASTM-D2665 or CSA B181.2

- Schedule 40, 80, 120 ASTM-D1785 or CSA B137.3
- SDR Series ASTM-D2241 or CSA B137.3

CPVC pipe materials:

- CPVC 41 ASTM-D2846 or CSA B137.6
- Schedule 40, 80 ASTM-F441 or CSA B137.6
- SDR Series ASTM-F442

Polypropylene - See Polypropylene Installations.

- M & G Duravent PolyPro vent system
- Centrotherm InnoFlue vent system

**NOTE:** The use of cellular core PVC (ASTM F891), cellular core CPVC, or Radel® (polyphenolsulfone) in non-metallic venting systems is prohibited. Covering non-metallic vent pipe and fittings with thermal insulation is prohibited. If the water heater is being installed as a replacement for an existing power vented heater in pre-existing venting, a thorough inspection of existing venting system must be performed prior to any installation work. Verify that correct material as detailed above has been used, and that the minimum or maximum vent lengths and terminal location as detailed in this manual have been met. Carefully inspect the entire venting system for any signs of cracks or fractures, particularly at joints between elbows and other fittings and straight runs of vent pipe. Check system for signs of sagging or other stresses in joints as a result of misalignment of any components in the system. If any of these conditions are found, they must be corrected in accordance with the venting instructions in this manual before completing installation and putting the water heater into service.

**NOTE:** For water heaters in locations with high ambient temperatures above 100°F (38°C) it is recommended that CPVC or Polypropylene pipe and fittings be used.

**NOTE:** Use only solid (not foam core) piping. Plastic pipe and fittings are available through most plumbing suppliers. Always check the marking on the pipe to make sure you are using the correct material.

## POLYPROPYLENE INSTALLATIONS

The water heater has been approved to be installed with Polypropylene vent material as shown in Table 5 and Table 6. The approved application of single wall, non-flexible, non-concentric Polypropylene vent material is offered by two specific manufacturers (Centrotherm ECO Systems and DuraVent Polypropylene). These listed products must be installed by following the vent manufacturer's instructions. Refer to Table 7 in Planning the Vent System on Page 24 to determine the maximum pipe length and number of elbows that can be used.

Insulation should not be used on Polypropylene venting materials. The use of insulation will cause increased vent wall temperatures, which could result in vent pipe failure.

Use only the adapters and vent system listed in Tables 5 and 6. DO NOT mix vent systems of different types or manufacturers. Failure to comply could result in severe personal injury, death, or substantial property damage.

Installations must comply with applicable national, state, and local codes. Polypropylene, PVC and CPVC vent must be listed as a ULC-S636 approved system. If Polypropylene vent is not required by your local code, you may use either PVC or CPVC pipes for your water heater that allows non-metallic venting material installations. Polypropylene vent systems do not use cement to connect the pipe and elbow sections but use a push together gasket seal method. Do not attempt to connect Polypropylene with sealant cement. All vent connections MUST be secured by the vent manufacturer's joint connector. The installer must use a specific vent starter adapter at the flue connection. The adapter is supplied by the vent manufacturer to adapt to its vent system.

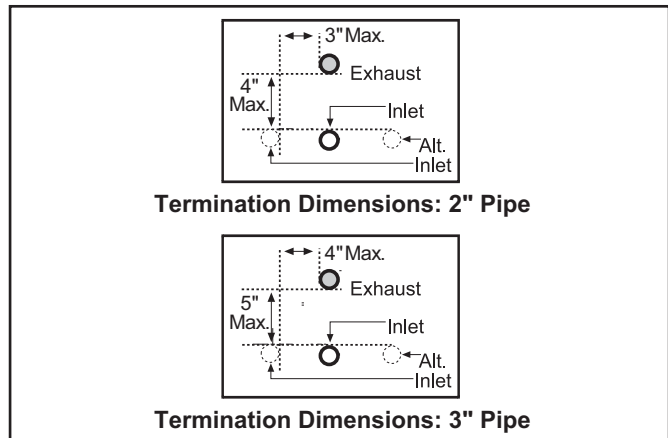
In order to be in full compliance with ULC-S636 and to meet the requirements of the water heater manufacturer, you must use the metal joint connector rings, available from the Polypropylene vent manufacturer, to stiffen the joints of 2", and 3" diameter pipes.

## VENT PIPE TERMINATION

The first step is to determine where the inlet and exhaust vent pipes will terminate. The combustion air inlet and exhaust outlet piping and terminations may be installed in one of the following termination types:

1. Standard Horizontal (2 Pipe) - See Figure 24
2. Alternate Horizontal (2 Pipe) - See Figure 20
3. Vertical (2 Pipe) - See Figures 21, 22, & 25
4. Concentric Vent Through the Wall - See Figure 30
5. Concentric Vent Through the Roof - See Figure 29

When venting one water heater, locate the inlet and exhaust terminations according to Figure 11 below. When installing more than one water heater, see Venting Multiple Units on Page 29.



**Figure 11.**

The vent system must terminate so that proper clearances are maintained as cited in local codes or the current edition of the Natural Gas and Propane Installation Code (CAN/CSA-B149.1). See Figure 23.

Instructions on proper installation through a sidewall are provided in Figure 18 and Figure 19. Plan the vent system layout so that proper clearances are maintained from plumbing and wiring.

Vent pipes serving power vented water heaters are classified by building codes as vent connectors. Required clearances from combustible materials must be provided in accordance with information in this manual under Locating The Water Heater on Page 14 and Installation Requirements starting on Page 16, and with the Natural Gas Propane Installation Code CAN/CSA B149.1. and local codes.

## PLANNING THE VENT SYSTEM

For water heater installations at elevations up to 2000 ft (610 m), size the exhaust and combustion air inlet pipes as specified in Table 7A. For water heater installations at elevations from 2000 ft (610 m) to 7,700 ft (2,347 m), size the exhaust and combustion air inlet pipes as specified in Table 7B. Tables 7A and 7B list the maximum allowable length in feet of the exhaust outlet and combustion air inlet pipes as related to the number of required elbows and the termination type. The specified maximum lengths are for the separate inlet and exhaust pipe systems and not the combined length of both systems. The minimum pipe length is 6 feet with one elbow per side.

**Table 5. M & G DuraVent PolyPro**

Nominal Pipe Diameter	Flue Outlet Adapter	Adapter Connector	Ring Connector	90 Degree Elbow	Vent Material	Terminal(s)
2"	2PPS-AD	PPS-PAC	2PPS-LB	2PPS-E90	2PPS	2PPS & 2PPS-BG for Exhaust; 2PPS-E90 & 2PPS-BG for Intake (Direct Vent only)
3"	3PPS-AD	PPS-PAC	3PPS-LB	3PPS-E90	3PPS	3PPS & 3PPS-BG for Exhaust; 3PPS-E90 & 3PPS-BG for Intake (Direct Vent only)

**Table 6. Centrotherm InnoFlue SW**

Nominal Pipe Diameter	Flue Outlet Adapter	Adapter Connector	Ring Connector	90 Degree Elbow	Vent Material	Terminal(s)
2"	ISAGL 0202	IAFC02	IAN502	ISELL0287	ISVL02	ISVL02 & IASPP02 for Exhaust; ISELL0287 & IASPP02 for Intake (Direct Vent only)
3"	ISAGL 0303	IAFC03	IAN503	ISELL0387	ISVL03	ISVL03 & IASPP03 for Exhaust; ISELL0387 & IASPP03 for Intake (Direct Vent only)

**Table 7A. Elevations up to 2000 Ft.**

Pipe Size (In)	Maximum Allowable Length in Feet of Exhaust and Air Inlet Pipe							Termination Option
	Number of 90° Elbows (See Note 4)							
	0	1	2	3	4	5	6	
*2	N/A	52	48	44	40	36	32	Std. Horizontal
*2	N/A	44	40	36	32	28	24	Alt. Horizontal
*2	52	48	44	40	36	32	28	Vertical
*2	N/A	52	48	44	40	36	32	Concentric
3	N/A	125	120	115	110	105	100	Std. Horizontal
3	N/A	115	110	105	100	95	90	Alt. Horizontal
3	130	120	115	110	105	100	95	Vertical
3	N/A	125	120	115	110	105	100	Concentric

**Notes:**

- N/A - Not Applicable
- Use only schedule 40 CPVC, PP, or PVC Pipe and Fittings
- The above maximum lengths are for the separate inlet and outlet pipe systems and not the combined length of both systems.
- Maximum of 6 elbows may be used per pipe. Use only short or long sweep elbows. See Figure 12 for details.
- Two 45° elbows are considered equivalent to one 90° elbow.
- Minimum length is 6 ft. per pipe with one elbow per side.
- 2" pipe may be used with 100,000, 130,000 & 150,000 BTU/Hr input models only.

\*3" Pipe must be used for 199,000 & 175,000 BTU/Hr

**Table 7B. Elevations from 2000 Ft. to 7,700 Ft.**

Pipe Size (In)	Maximum Allowable Length in Feet of Exhaust and Air Inlet Pipe							Termination Option
	Number of 90° Elbows (See Note 4)							
	0	1	2	3	4	5	6	
*2	N/A	42	38	34	30	26	22	Std. Horizontal
*2	N/A	34	30	26	22	18	14	Alt. Horizontal
*2	42	38	34	30	26	22	18	Vertical
*2	N/A	42	38	34	30	26	22	Concentric
3	N/A	105	100	95	90	85	80	Std. Horizontal
3	N/A	95	90	85	80	75	70	Alt. Horizontal
3	110	100	95	90	85	80	75	Vertical
3	N/A	105	100	95	90	85	80	Concentric

**Notes:**

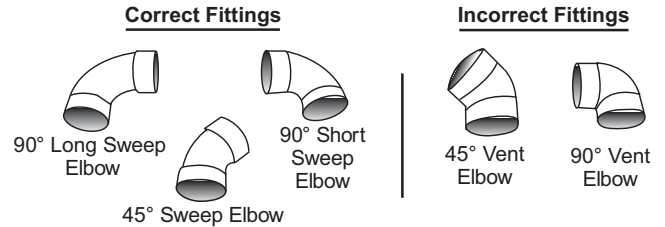
- N/A - Not Applicable
- Use only schedule 40 CPVC, PP, or PVC Pipe and Fittings
- The above maximum lengths are for the separate inlet and outlet pipe systems and not the combined length of both systems.
- Maximum of 6 elbows may be used per pipe. Use only short or long sweep elbows. See Figure 12 for details.
- Two 45° elbows are considered equivalent to one 90° elbow.
- Minimum length is 6 ft. per pipe with one elbow per side.
- 2" pipe may be used with 100,000, 130,000 & 150,000 BTU/Hr input models only.

\*3" Pipe must be used for 199,000 & 175,000 BTU/Hr

- Determine termination type and pipe size.
- Determine number of elbows in exhaust pipe. Do not include the elbows in the termination or the condensate trap. Corresponding number in Table 7 indicates the maximum length of exhaust pipe.
- Determine number of elbows in inlet pipe. Do not include the elbows in the termination. The corresponding number in Table 7 indicates the maximum length of inlet pipe.

**NOTE:** Use Table 7A at elevations up to 2000 ft (610 m) and use Table 7B at elevations from 2000 ft (610 m) to 7,700 ft (2,347 m).

**IMPORTANT:** Do not use vent elbows in this vent pipe installation. See Figure 12.



**Figure 12. Correct and Incorrect Pipe Fittings**

**INTEGRATED FILTER INSTALLATION**

The air intake filter included with the unit must be installed according to the installation instructions supplied with the filter. Installation steps are shown in Figures 13-16.

When installing the adaptor rubber boot, note the following:

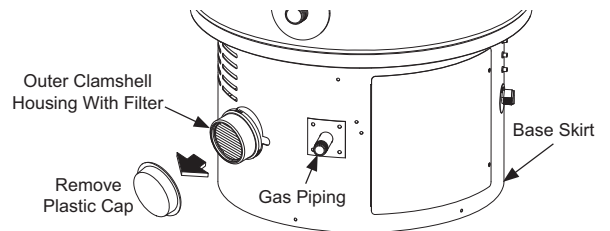
- Remove and discard the plastic cap from the outer clamshell housing. See Figure 13.
- To connect heater to the air inlet, use the vent adaptor rubber boot provided in the base skirt. The adaptor rubber boot is designed for 3" venting (Figure 14).

**NOTE:** if there is a need for 2" venting, then use plastic pipe fittings to transition down.

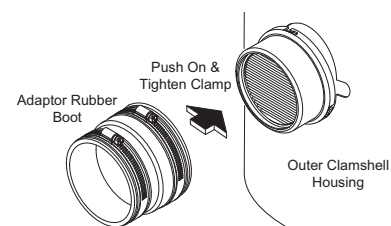
- Loosen the hose clamp at the adaptor rubber boot and slide the plastic piping into the adaptor rubber boot. With piping in place, tighten the hose clamp. Install a 3" x 3" x 2" drain/waste/vent fitting to trap airborne particulates. See Figure 15.

**NOTE:** If piping has been previously cut with a saw, be sure to remove all burrs and plastic shavings from the piping before installing.

**NOTE:** The heater must never be operated without the filter media installed.

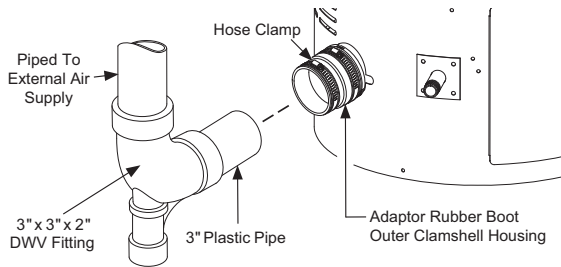


**Figure 13. Remove Plastic Cap**

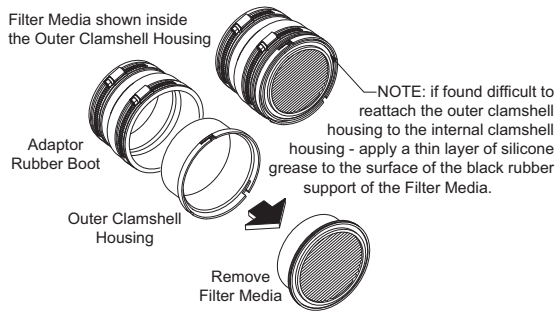


**Figure 14. Adapter Rubber Boot**





**Figure 15. Air Inlet Piping**



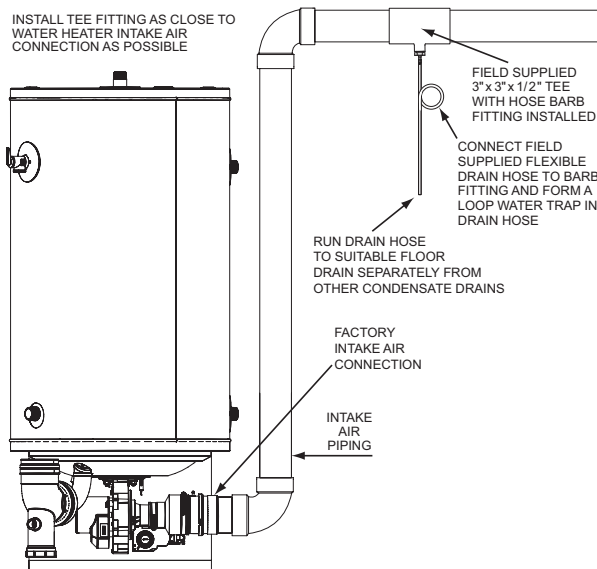
**Figure 16. Filter Media**

**DIRECT VENT AIR INTAKE MOISTURE PROTECTION**

The air intake piping in a direct vent system will normally not have any moisture accumulation in it. However, in certain cases, moisture may build up and needs to be drained. Typical situations include, but are not limited to:

- Cold outdoor temperature, particularly if the air inlet is short,
- Heater being used mostly for space heating,
- Air inlet pipe has vertical rise near the heater and,
- High outdoor humidity.

Installations with any of these conditions are required to provide a moisture drain with a trap that flows to a waste drain. See Figure 17. Install a drain tee assembly and a trap in the inlet vent as close to the water heater as possible. This is to drain any water that may be in the combustion air pipe and prevent it from entering the blower. The drain tubing in any installation should have a loop trap and flow to an appropriate waste drain. The air intake drain line must be entirely separate from the exhaust vent outlet condensate line.



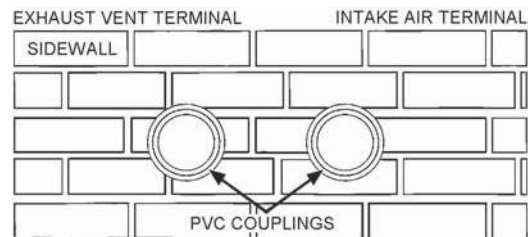
**INTAKE AIR CONDENSATE TEE INSTALLATION**

**Figure 17**

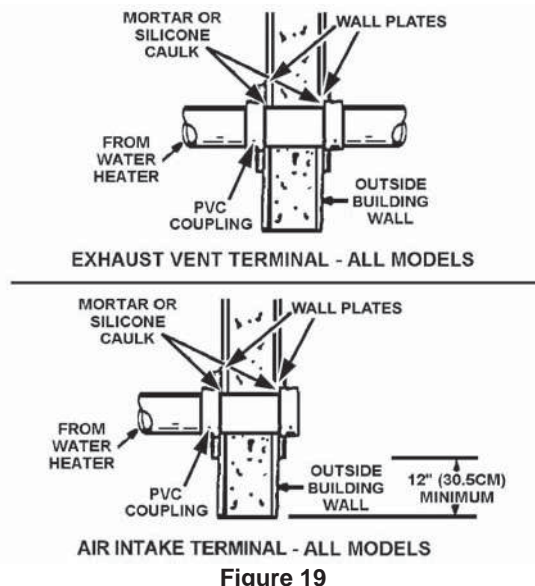
**HORIZONTAL VENT TERMINAL INSTALLATION**

**NOTE:** If you are installing your system so that it vents through the roof, please refer to Vertical Vent Terminal Installation on Page 25.

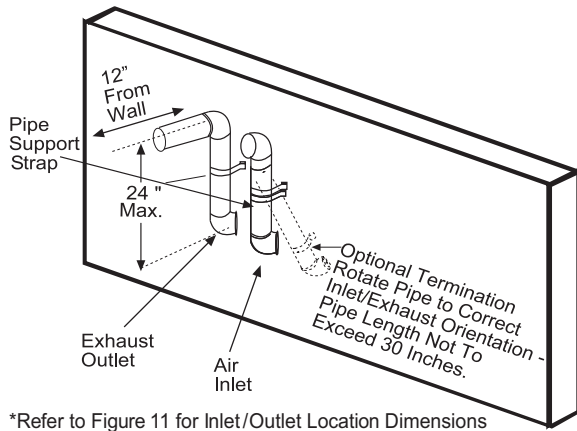
1. After the points of termination have been determined (see Vent Pipe Termination on page 22) use the cover plates as templates to mark the holes for the vent pipes to be inserted through the wall. **BEWARE OF CONCEALED WIRING AND PIPING INSIDE OF WALL.** If the vent terminals are being installed on the outside of a finished wall, it may be easier to mark both the inside and outside wall. Align the holes by drilling a hole through the center of the template from the inside through to the outside. The template can now be positioned on the outside wall using the drilled holes as a centering point for the template.
  - A.) **MASONRY SIDE WALLS** Chisel an opening approximately 1/2" (1.3 cm) larger than the marked circle.
  - B.) **WOODEN SIDE WALLS** Drill a pilot hole approximately one quarter inch outside of the marked circle. This pilot hole is used as a starting point for a saws-all or sabre saw blade. Cut around the marked circle staying approximately one quarter inch outside of the line. (This will allow the vent pipe to easily slide through the opening. The resulting gap will be covered by the vent terminal cover plates.) Repeat this step on the inside wall if necessary.
2. Cut a length of pipe about 3.5" (8.9 cm) longer than the wall thickness at the opening.
3. Glue the air intake terminal to the section of the pipe.
4. Slide the wall plate over pipe to stop against air intake terminal.
5. Place a bead of caulking (not supplied) around the gap between the pipe and the wall. Place some of the caulking on the back of the plate to hold it against the wall after installation.
6. If the air intake pipe is installed up to the wall, with a coupling on the end against the wall opening, the pipe with the air intake terminal can be prepared for gluing before inserting through the wall. Slide the pipe through the wall and insert into coupling on the other side of the wall. See Figure 18 and Figure 19.
7. Refer to Figure 11 in "Vent Pipe Termination" for standard and alternate vent termination dimensions.
8. Refer to Figure 20 below for the Alternate Horizontal Termination installation.



**Figure 18**



**Figure 19**



\*Refer to Figure 11 for Inlet/Outlet Location Dimensions

**Alternate Horizontal Termination**  
**Figure 20**

**VERTICAL VENT TERMINAL INSTALLATION**

The vertical inlet air termination requires a return bend or two short or long sweep radius 90 elbows to keep the inlet downward

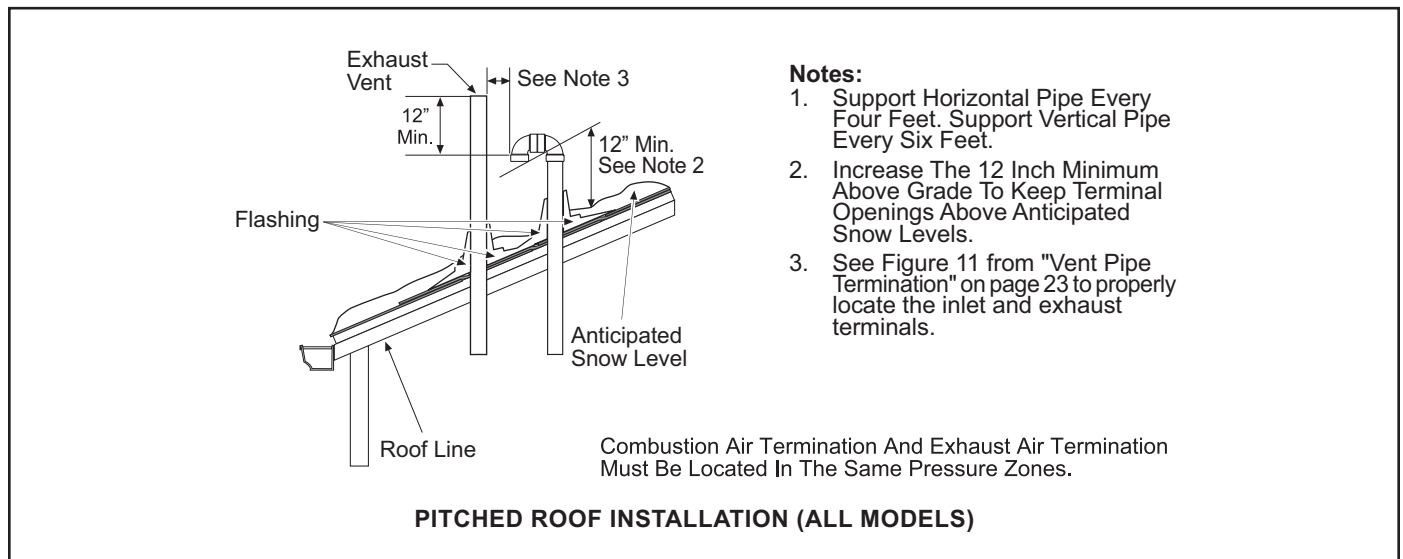
and prevent entry of rain. These elbows are considered part of the termination and should not be included when calculating the maximum allowable vent pipe length. Refer to Figures 21 and 22 for the proper location of the air inlet with respect to the exhaust outlet termination. The air inlet and exhaust outlet terminations must be at least 12 inches above the roof line or anticipated snow levels.

WHEN TERMINATING THROUGH A ROOF, THE FOLLOWING SPECIFICATIONS PERTAINING TO TERMINAL LOCATION MUST BE FOLLOWED.

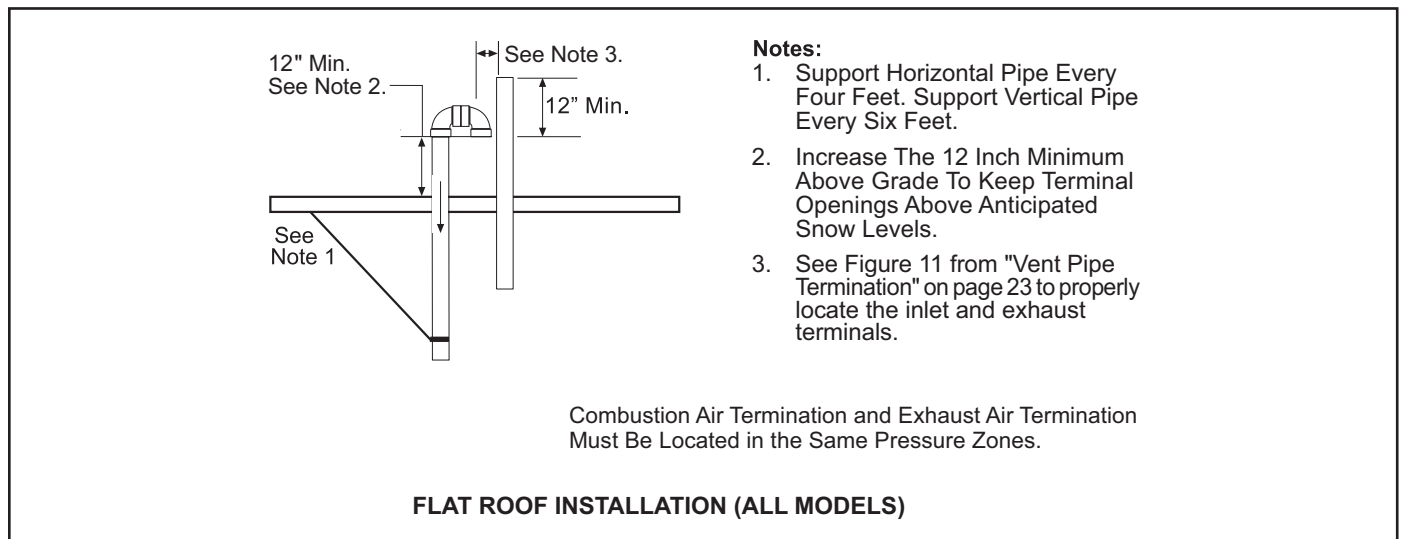
1. Support horizontal pipe every four feet. Support vertical pipe every six feet.
2. Increase the 12 inch minimum above grade to keep terminal openings above anticipated snow levels.

**FLAT ROOF INSTALLATION**

On flat roof installations the air intake and the exhaust vent terminations must be a minimum of 24 inches (60 cm) above any parapet, vertical wall or structure within 10 feet (3 m) horizontally.



**Figure 21**



**Figure 22**

# TERMINATION CLEARANCES SIDEWALL DIRECT VENT

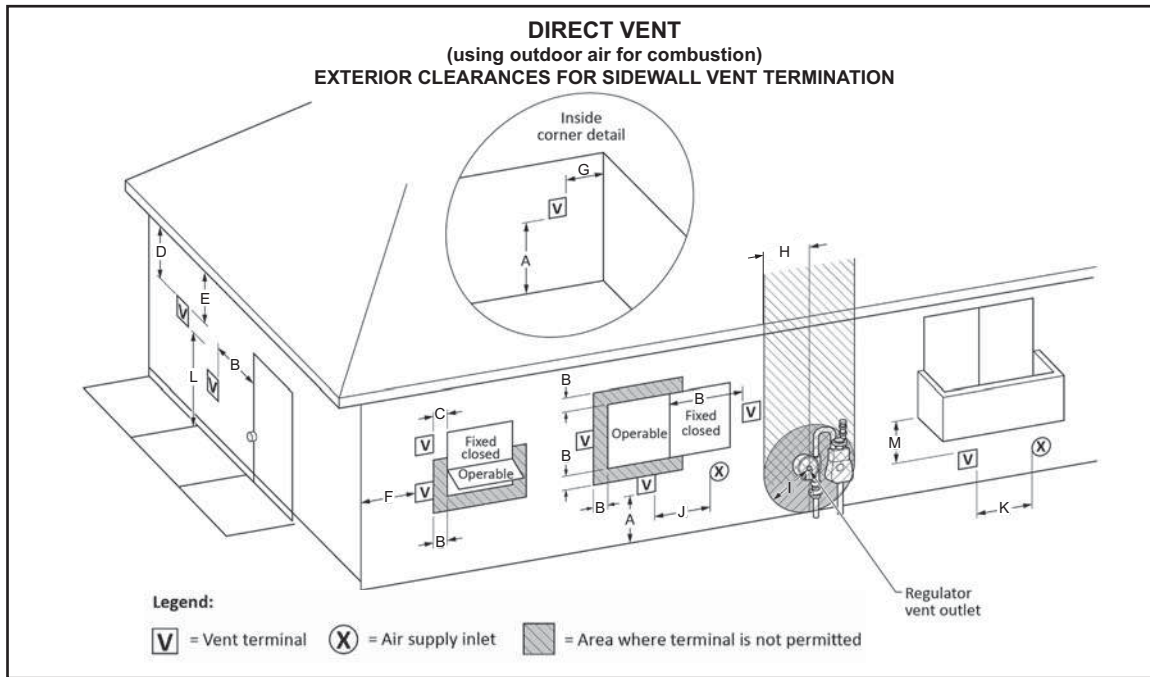


Figure 23

Vent terminal clearances for “Direct Vent” installations. Direct Vent configurations use outdoor air for combustion.

CANADIAN INSTALLATIONS <sup>1</sup>		CANADIAN INSTALLATIONS <sup>1</sup>		
<b>A</b>	Clearance above grade, veranda, porch, deck or balcony	12 inches (30 cm)	<b>H</b> Clearance to each side of center line extended above meter/regulator assembly	Clearance in accordance with local installation codes and the requirements of the gas supplier.
<b>B</b>	Clearance to window or door that may be opened	6 in (15 cm) for appliances ≤ 10,000 Btuh (3 kW), 12 in (30 cm) for appliances > 10,000 Btuh (3 kW) and ≤ 100,000 Btuh (30 kW), 36 in (91 cm) for appliances >100,000 Btuh (30 kW)	<b>I</b> Clearance to service regulator vent outlet	Above a regulator within 3 ft (91 cm) horizontally of the vertical center line of the regulator vent outlet to a maximum vertical distance of 15 ft (4.5 m)
<b>C</b>	Clearance to permanently closed window	6 inches (15 cm)*	<b>J</b> Clearance to a non mechanical air supply inlet into building or combustion air inlet to any other appliance	6 in (15 cm) for appliances ≤ 10,000 Btuh (3 kW), 12 in (30 cm) for appliances > 10,000 Btuh (3 kW) and ≤ 100,000 Btuh (30 kW), 36 in (91 cm) for appliances >100,000 Btuh (30 kW)
<b>D</b>	Vertical clearance to ventilated soffit located above the terminal within a horizontal distance of 2 feet (61 cm) from the center line of the terminal	12 inches (30 cm)*	<b>K</b> Clearance to a mechanical air supply inlet	6 feet (1.83 m)
<b>E</b>	Clearance to unventilated soffit	12 inches (30 cm)*	<b>L</b> Clearance above paved sidewalk or paved driveway located on public property	7 feet (2.13 m) †
<b>F</b>	Clearance to outside corner	2 feet (60 cm)*	<b>M</b> Clearance under veranda, porch, deck, or balcony	12 inches (30 cm) ‡
<b>G</b>	Clearance to inside corner	18 inches (45 cm)*		

<sup>1</sup> In accordance with the current CSA B149.1, Natural Gas and Propane Installation Code.

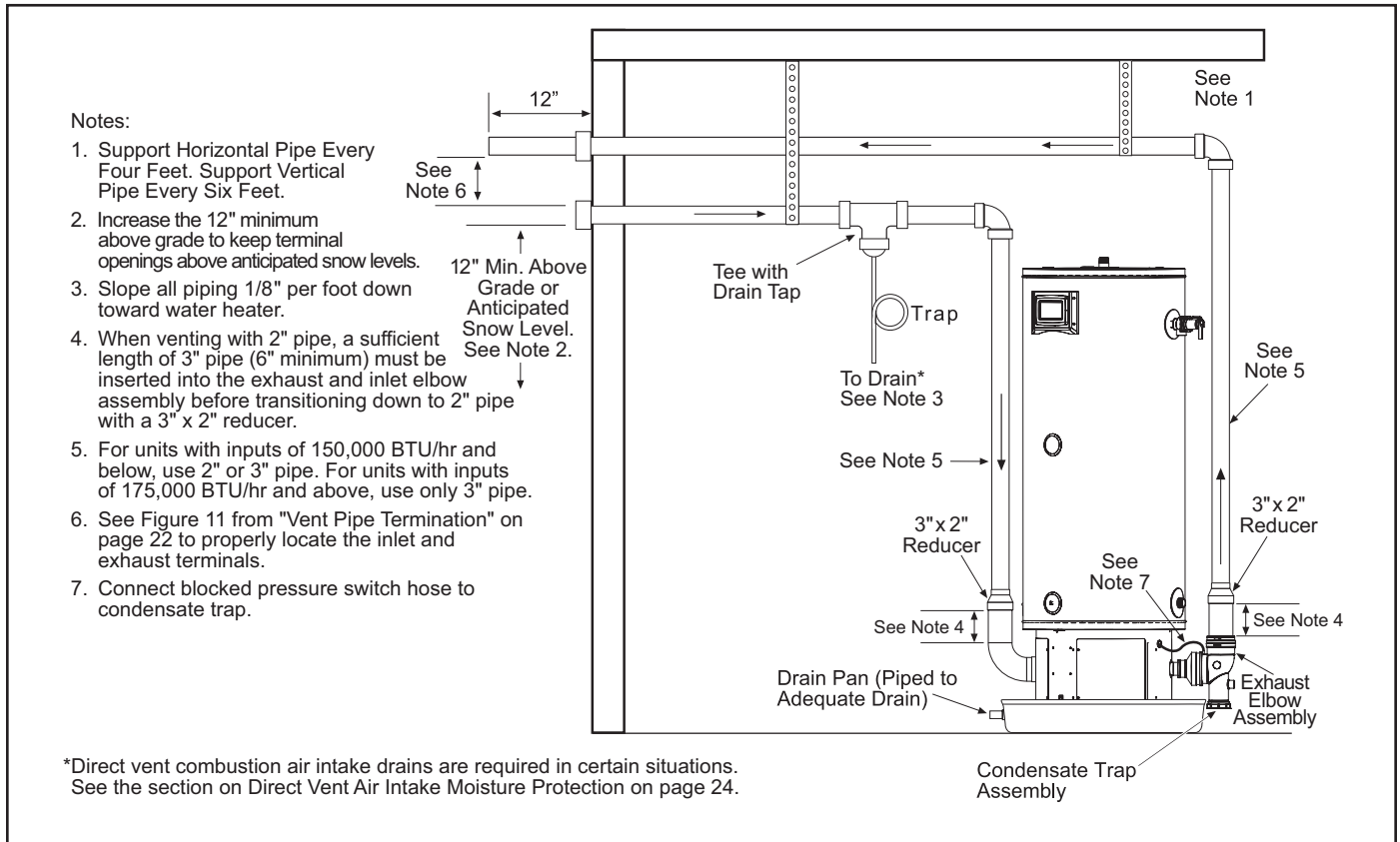
† A vent shall not terminate directly above a sidewalk or paved driveway that is located between two single family dwellings and serves both dwellings. Where it may cause hazardous frost or ice accumulations on adjacent property surfaces.

‡ Permitted only if veranda, porch, deck, or balcony is fully open on a minimum of two sides beneath the floor.

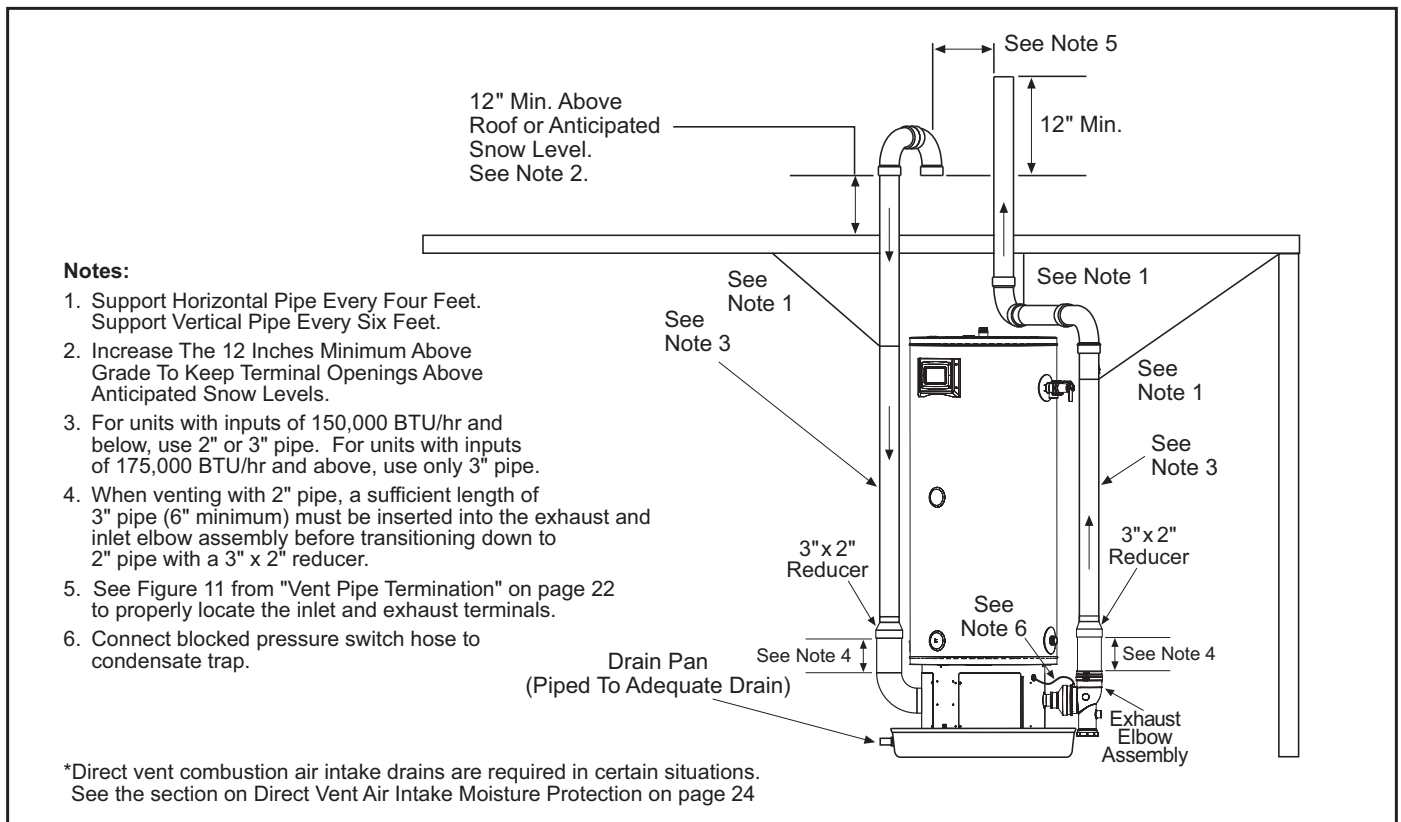
\* Clearance in accordance with local installation codes and the requirements of the gas supplier and the manufacturer’s installation instructions.



# DIRECT VENT INSTALLATION DIAGRAMS



**Figure 24. SIDEWALL VENT INSTALLATION (ALL MODELS)**



**Figure 25. ROOF VENT INSTALLATION (ALL MODELS)**

## CONCENTRIC VENT INSTALLATION

For new installations of 100,000, 130,000 & 150,000 BTU/hr units, install 2" Concentric vent kit model KGAVT0501CVT, part number 100093946. For new installations of 175,000 & 199,000 btu/hr units, install 3" Concentric vent kit model KGAVT0601CVT, part number 100093947. See Manufacturer's instructions for complete installation or call the technical support number listed on the back cover of this manual. For planning purposes, see Figures 26 through 30 below for vent terminal specifications.

**Note:** When terminating concentric vents for additional units (all models), see "Venting Multiple Units" on Page 29.

Field supplied pipe and fittings are required to complete the installation.

### SAFETY CONSIDERATIONS

Installing and servicing water heating equipment can be hazardous due to gas and electrical components. Installation and service of the concentric vent termination requires ability equivalent to that of a qualified installer or qualified service technician, see Page 7. All precautions in the literature, on tags, and labels attached to the unit must be observed.

Follow all safety codes. Wear safety glasses and work gloves.

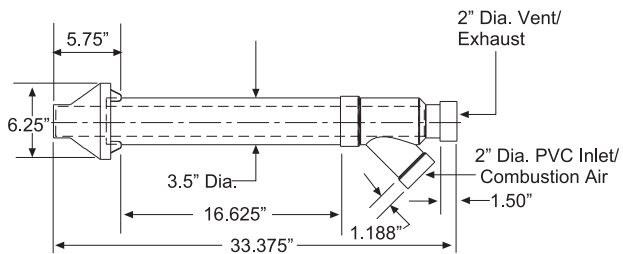


Figure 26. 2 Inch Concentric Vent

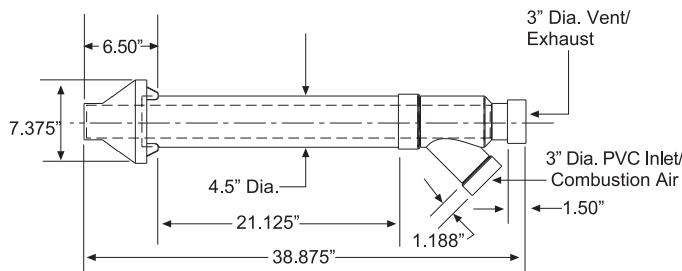


Figure 27. 3 Inch Concentric Vent

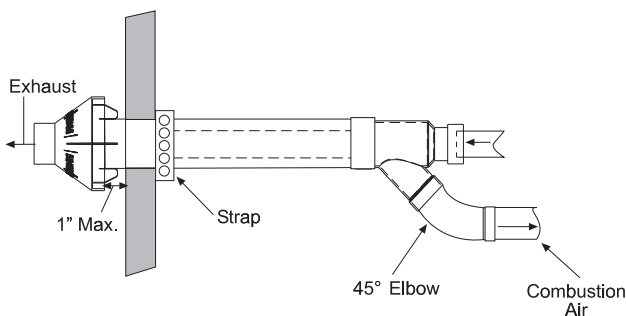


Figure 28. Through the Wall Termination

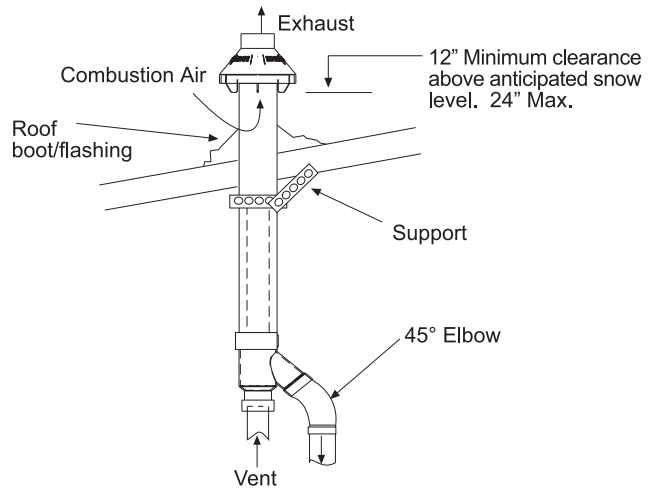
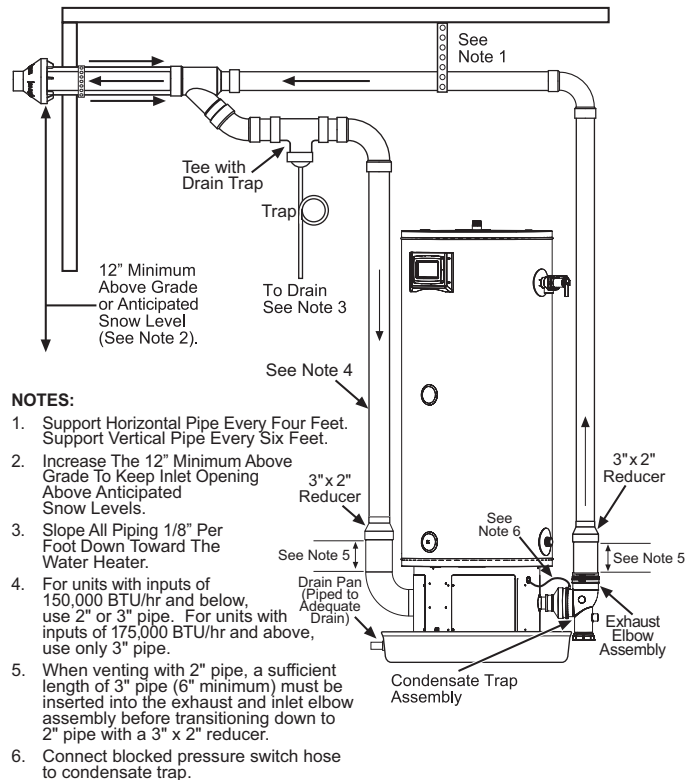


Figure 29. Through the Roof Termination



#### NOTES:

1. Support Horizontal Pipe Every Four Feet. Support Vertical Pipe Every Six Feet.
2. Increase The 12" Minimum Above Grade To Keep Inlet Opening Above Anticipated Snow Levels.
3. Slope All Piping 1/8" Per Foot Down Toward The Water Heater.
4. For units with inputs of 150,000 BTU/hr and below, use 2" or 3" pipe. For units with inputs of 175,000 BTU/hr and above, use only 3" pipe.
5. When venting with 2" pipe, a sufficient length of 3" pipe (6" minimum) must be inserted into the exhaust and inlet elbow assembly before transitioning down to 2" pipe with a 3" x 2" reducer.
6. Connect blocked pressure switch hose to condensate trap.

Figure 30. Concentric Vent Piping Installation

## VENTING MULTIPLE UNITS

### VENTING ADDITIONAL POLARIS® UNITS (100,000, 130,000 & 150,000 BTU/HR MODELS)

When using two water heaters with inputs of 150,000 BTH/HR or below, install vent terminations using either Method A or Method B below:

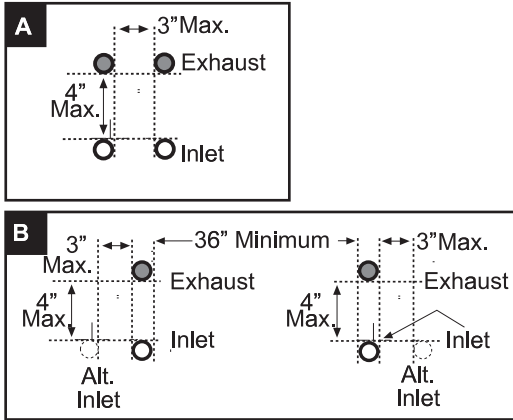


Figure 31

When using three or more water heaters with inputs of 150,000 BTH/HR or below, install vent terminations per Method C or Method D:

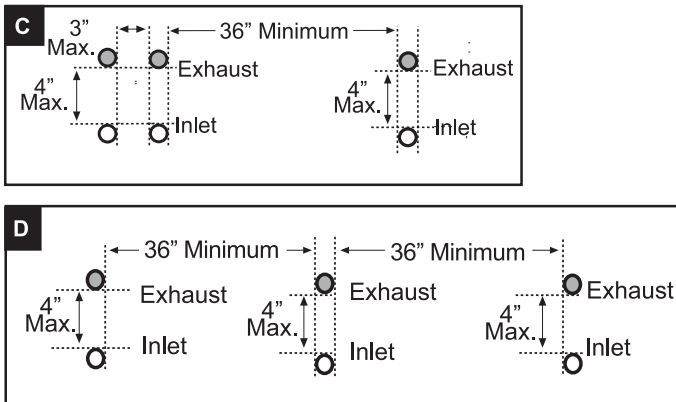


Figure 32

### VENTING ADDITIONAL POLARIS® UNITS (175,000 & 199,000 BTU/HR MODELS)

When using two water heaters with inputs of 175,000 BTH/HR or above, install vent terminations using either Method A or Method B below:

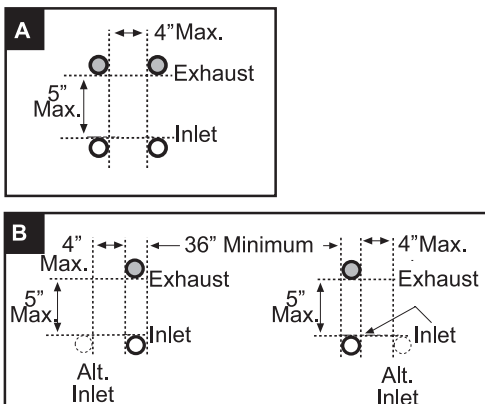


Figure 33

When using three or more water heaters with inputs of 175,000 BTH/HR or above, install vent terminations per Method C or Method D:

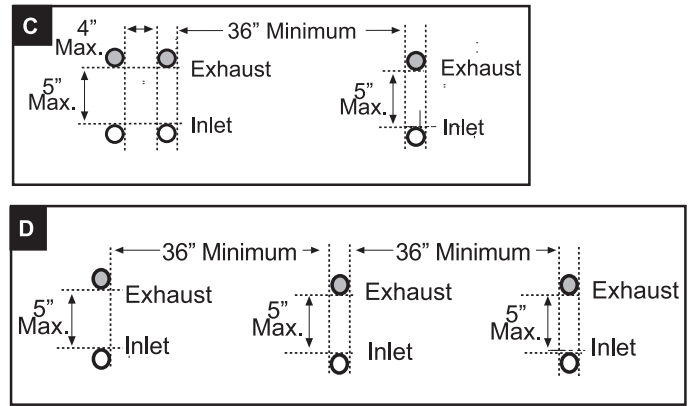
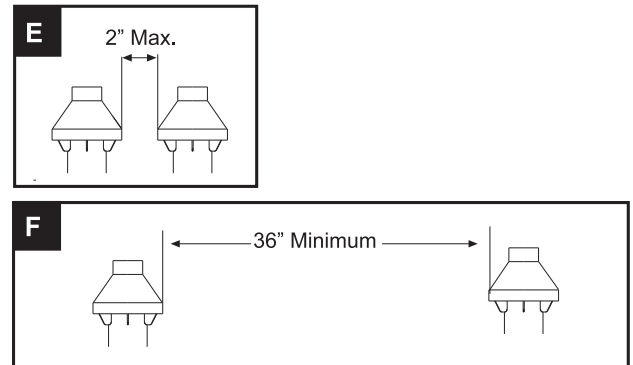


Figure 34

### CONCENTRIC VENTING MULTIPLE WATER HEATERS (ALL MODELS)

When concentric venting two water heaters, install vent terminations using either Method E or Method F below:



When concentric venting three or more water heaters, install vent terminations using Method G below:

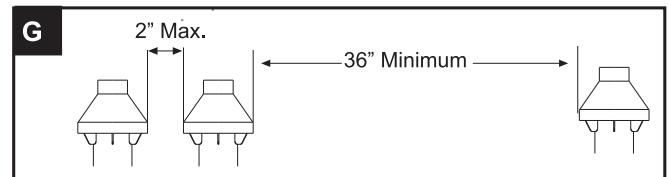


Figure 35

# WATER HEATER INSTALLATION

## CONDENSATE DRAIN INSTALLATION

1. Ensure the water heater's enable/disable switch is in the "disable" position.
2. Install a 1/2 inch PVC condensate drain line between condensate drain connection on the Exhaust/Condensate Elbow and a suitable building drain with a slight downward slope to drain. The exhaust elbow has a "built in" condensate trap. Do not install an additional trap in the condensate drain piping. See Figure 36.
3. Terminate the condensate drain piping with an elbow above the drain. Ensure that any discharge will exit the condensate drain line no more than 6 inches (15.2 cm) above a suitable building drain, or external to the building, see Figure 36.

**NOTE:** In cold climates it is recommended the condensate drain be terminated at a suitable drain inside the building.

4. Ensure the condensate drain line is not elevated above the condensate drain connection on the Exhaust/Condensate Elbow, see Figure 36.
5. Brace the condensate drain line with floor mounted standoffs every three feet.
6. Ensure the condensate drains freely during start up and the condensate clean out cap is on and tight when unit is in operation.
7. Condensate clean out cap must be on and tight when unit is in operation.
8. Connect blocked pressure switch hose to condensate trap (pressure port).

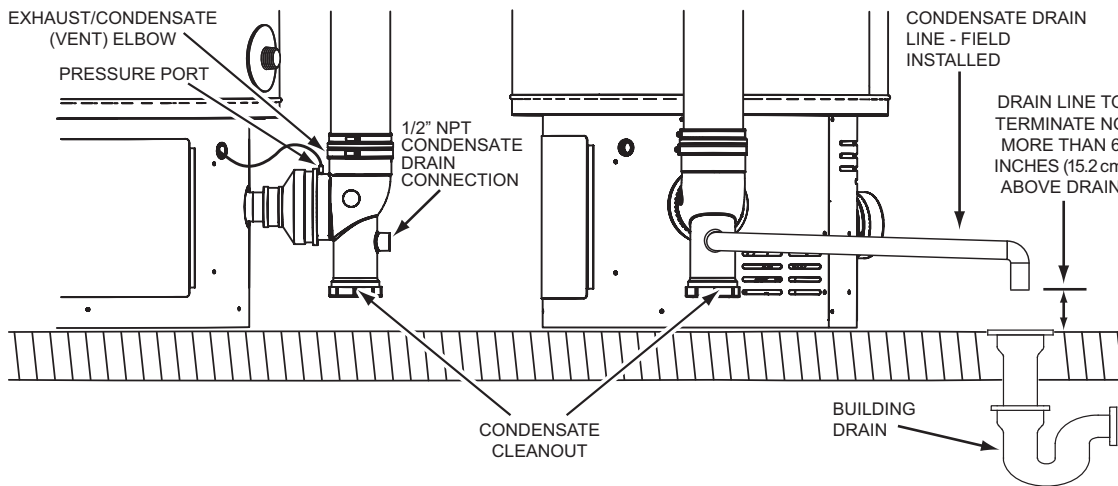


Figure 36

## SUPPLY GAS LINE INSTALLATION

Contact your local gas utility company to ensure that adequate gas service is available and to review applicable installation codes for your area.

Be sure that the gas meter has sufficient capacity to supply the rated gas input of the water heater as well as the requirements of all other gas fired equipment supplied by the meter. If the gas meter is undersized, the gas company will have to install a properly sized gas meter.

Make sure the gas supplied is the same type listed on the water heaters rating label.

The gas piping must be installed according to all local and state codes or in absence of local and state codes with the Natural Gas Propane Installation Code CAN/CSA B149.1 current edition.

Schedule 40 Steel or Wrought Iron Pipe is the preferred material for the gas line of this water heater. It is imperative to follow the sizing recommendations in the latest version of the National Fuel Gas Code if Corrugated Stainless Steel Tubing (CSST) is used as the gas line for this water heater.

Tables 8, 9, and 10 on Page 31 are provided as a sizing reference for commonly used gas pipe materials. Consult the Natural Gas Propane Installation Code CAN/CSA B149.1. for the recommended gas pipe size of other materials.

Follow the instructions below and reference Figure 37 for gas piping installation.

1. Apply thread sealing compounds (pipe dope/ Teflon tape) sparingly and only to the male threads of the pipe joints. Do not apply sealing compound to the first two threads. Use pipe dope or Teflon tape marked as being resistant to the action of liquid petroleum (LP/propane) gases.

2. Install a readily accessible manual shut-off valve in the gas supply line as recommended by the local utility. Know the location of this valve and how to turn off the gas to this unit.
3. Install a sediment trap as shown. The sediment trap must be no less than 3 inches long for the accumulation of dirt, foreign material and water droplets.
4. Install a ground union between the water heater and the manual shut-off valve. This is to allow easy servicing. See Figure 37 below.
5. Turn the gas supply on and check for leaks. See Gas Line Leak Testing on Page 31. Use a chloride-free soap and water solution (bubbles forming indicate a leak) or other approved method.

**NOTE:** Units with inputs of 175,000 BTU/HR or above must have a minimum of 3/4" NPT gas pipe supplied to the water heater.

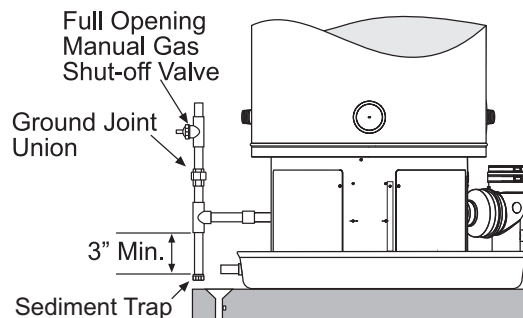


Figure 37

**Table 8. Natural Gas Capacity (Cu. ft/hr)**

Capacity of gas pipe of different diameters and lengths in cu. ft. per hr. with pressure drop of 0.3 in. and specific gravity of 0.60 (natural gas).														
Nominal Iron Pipe Size, in.	Length of Pipe, Feet													
	10	20	30	40	50	60	70	80	90	100	125	150	175	200
1/2	132	n/a	n/a	n/a	n/a	n/a	n/a	n/a	n/a	n/a	n/a	n/a	n/a	n/a
3/4	278	190	152	130	115	105	96	n/a	n/a	n/a	n/a	n/a	n/a	n/a
1	520	350	285	245	215	195	180	170	160	150	130	120	110	100
1-1/4	1050	730	590	500	440	400	370	350	320	305	275	250	220	210
1-1/2	1600	1100	890	760	670	610	560	530	490	460	410	380	350	320

After the length of pipe has been determined, select the pipe size which will provide the minimum cubic feet per hour required for the gas input rating of the water heater. By formula:

$$\text{Cu. Ft. Per Hr. Required} = \frac{\text{Gas Input of Water Heater (BTU/HR)}}{\text{Heating Value of Gas (BTU/FT}^3\text{)}}$$

The gas input of the water heater is marked on the water heater data plate. The heating value of the gas (BTU/FT<sup>3</sup>) may be determined by consulting the local natural gas utility.

**Table 9. L.P. Gas Capacity**

Maximum capacity of pipe in thousands of BTU per hour of undiluted liquefied petroleum gases (at 11 inches water column pressure). Based on a Pressure Drop of 0.5 Inch Water Column.														
Nominal Iron Pipe Size, in.	Length of Pipe, Feet													
	10	20	30	40	50	60	70	80	90	100	125	150		
1/2	275	189	152	n/a	n/a	n/a	n/a	n/a	n/a	n/a	n/a	n/a	n/a	n/a
3/4	576	393	315	267	237	217	196	185	173	162	146	146	132	132
1	1071	732	590	504	448	409	378	346	322	307	275	252	252	252
1-1/4	2205	1496	1212	1039	913	834	771	724	677	630	567	511	511	511

Example: Input BTU requirement of the water heater, 199,000 BTUH  
Total pipe length, 80 feet = 1" IPS required.


**Table 10. L.P. Gas Capacity**

Maximum capacity of pipe in thousands of BTU per hour of undiluted liquefied petroleum gases (at 11 inches water column pressure). Based on a Pressure Drop of 0.5 Inch Water Column.											
Copper Tubing O.D. Size, in.	Length of Pipe, Feet										
	10	20	30	40	50	60	80	100	125		
5/8	206	141	n/a	n/a	n/a	n/a	n/a	n/a	n/a	n/a	
3/4	348	239	192	164	146	132	n/a	n/a	n/a	n/a	
7/8	536	368	296	253	224	203	174	154	137	137	

Example: Input BTU requirement of the water heater, 199,000 BTUH  
Total pipe length, 50 feet = 7/8" IPS required.

Additional tables are available in the current edition of the Natural Gas Propane Installation Code CAN/CSA B149.1

**GAS LINE LEAK TESTING**



⚠ WARNING

Fire and Explosion Hazard

- Use joint compound or Teflon tape compatible with propane gas.
- Leak test gas connections before placing water heater in operation.
- Disconnect gas piping at main gas shutoff valve before leak testing heater.
- Install sediment trap in accordance with CAN/CSA B149.1.

1. For test pressures exceeding 1/2 psi (3.45 kPa) disconnect the water heater and its Main Gas Shutoff Valve from the gas supply piping system during testing, see Figure 37 on page 30. The gas supply line must be capped when disconnected from the water heater.
2. For test pressures of 1/2 psi (3.45 kPa) or less, the water heater need not be disconnected, but must be isolated from the supply gas line by closing the Main Gas Shutoff Valve during testing.
3. Paint all supply gas line joints and connections upstream of the water heater with a rich soap and water solution to test for leaks. Bubbles indicate a gas leak. Do not use matches, candles, flame or other sources of ignition for this purpose.
4. Repair any leaks before placing the water heater in operation.

**PURGING**

Gas line purging is required with new piping or systems. Purging should be performed per the current edition of NFPA 54 the National Fuel Gas Code.

Any time work is done on the gas supply system perform a leak test to avoid the possibility of fire or explosion.



## ELECTRICAL WIRING

If you lack the necessary skills required to properly install the electrical wiring to this water heater, do not proceed but have a qualified electrician perform the installation. Refer to the Power Supply section on Page 18 for additional requirements.

When making the electrical connections, always make sure:

- The voltage and frequency must correspond to that specified on the water heater data plate on the front of the water heater.
- The electrical supply has the proper overload fuse or breaker protection. The heater draws less than 7 amps.
- Wire sizes, connections and conduits comply with all applicable codes.
- The water heater and electrical supply are properly grounded.
- This water heater must be “hard-wired” do not use an extension cord to supply electrical power to this water heater.

**NOTE:** The wiring diagram can be found in Figure 49 on page 56. Always reference the wiring diagram(s) for the correct electrical connections.

When installing the electrical wiring to the water heater:

1. Shut off the power at the electrical service box.
2. Loosen the screws securing the access panel to the electrical compartment. (The electrical wiring diagram for all models can be found on the inside of the access panel at the base of the water heater. Set the access panel aside.
3. Connect the electrical supply to the water heater in accordance with local utility requirements and codes. Use only a dedicated electrical circuit containing a properly sized fuse or circuit breaker. Maximum overload protection should not exceed 15 amperes.
4. Connect this circuit (directly from the electrical service box) to an electrical disconnect switch.
5. Ground the water heater by connecting the electrical service ground wire to the green ground wire (provided).

**NOTE:** The power supply to this water heater must be properly polarized, [120 volts from the hot lead (black) to ground and 0 volts from the neutral lead (white) to ground] otherwise, the unit will not operate.

6. After making all electrical connections, completely fill the tank with water and check all connections for leaks. Open the nearest hot water faucet and let it run for 3 minutes to purge the water lines of air and sediment and to ensure complete filling of the tank. The electrical power may then be turned on. See Page 43 for the complete Start Up instructions.

## ENABLE/DISABLE CIRCUIT (For Building Management Systems)

The water heaters covered in this manual are equipped with an enable/disable circuit for use with field supplied external supervisory controls such as time clocks or Building Management Systems. The enable/disable circuit may be used to disable heating operation during periods when the building is unoccupied or there is no demand for hotwater.

To use the enable/disable circuit it must first be activated by selecting the “Use External Enable” from the UIM. Field supplied wiring is then installed between the water heater’s CCB and a set of “dry contacts” (no voltage or load) on the field supplied external control.

**NOTE:** The water heater’s enable/disable circuit is a switching circuit only: Do not apply external voltage or connect any load (IE: relay coil) to this circuit. This will damage the CCB circuit board and is not covered under the limited warranty.

## CONNECTING AN EXTERNAL SUPERVISORY CONTROL

The enable/disable circuit is accessed from the CCB’s J17 plug inside the CCB enclosure; see Figure 3 on page 11 to locate the

CCB enclosure and Figure 48 on page 55 for the CCB layout.

Install field wiring to the enable/disable circuit:

1. Turn off power at the water heater’s enable/disable switch and the breaker that supplies power to the water heater.
2. Locate the CCB enclosure.
3. Carefully remove the Temperature Probe connectors and CCB enclosure cover.
4. Locate pins 1 and 2 on the CCB J17 plug. See Figure 48 on page 55.
5. Connect the two field supplied control wires to pins 1 and 2 on the CCB J17 plug.
6. Thread the control wires out of the CCB enclosure with the other wiring and carefully replace the CCB enclosure cover. Ensure all wiring is routed through the intended area provided for strain relief. Ensure no wiring is being pinched.
7. Reinstall the CCB enclosure cover.
8. Route the control wires inside the junction box on the top of the water heater; see Figure 3 on page 11 to locate the junction box. Use an available knock-out to route the wires inside the junction box.
9. Install field supplied control wiring and conduit as required by national and local codes between the water heater’s junction box and the external supervisory control. Connect the wiring from the external control to the control wires inside the junction box using wire nuts and electrical tape.
10. Connect the control wiring to a set of dry contacts on the external control. Follow the control manufacturer’s instructions for making connections.
11. Restore power to the water heater.
12. From the water heaters UIM “Heater Information Screen” select “Use External Enable” and change to “Yes”. See Figure 3 on page 11 to locate the UIM.

**NOTE:** Whenever the external control opens the set of dry contacts used, water heating operation will be disabled. Whenever the external control closes the set of dry contacts used, water heating operation will be enabled. A diagonal line and circle appears over the thermometer icon on the UIM when water heating operation is disabled. See the Status Icons descriptions in Table 12 on page 36.

**NOTE:** Ensure the water heater is protected from freezing temperatures when water heating operation is disabled. Damage to the water heater caused by freezing temperatures is not covered under the limited warranty.

## WATER LINE CONNECTIONS

The water piping installation must conform to these instructions and to all local and national code authority having jurisdiction. Good practice requires that all heavy piping be supported.

Read and observe all requirements in the following sections before installation of the water piping begins:

1. Mixing Valves on page 17.
2. Temperature-Pressure Relief Valve on page 19.
3. Closed Systems and Thermal Expansion on page 18.

## WATER PIPING DIAGRAMS

This manual provides detailed water piping diagrams for typical methods of application for the water heaters, see Piping Diagrams beginning on Page 58.

The water heater may be installed by itself, or with a separate storage tank. When used with a separate storage tank, the circulation may be either by gravity or by means of a circulating pump. When a



circulating pump is used, it is important to note that the flow rate should be slow so that there will be a minimum of turbulence inside the water heater storage tank.

Adjust flow by throttling a full port ball valve installed in the circulating line on the outlet side of the pump. Never throttle flow on the suction side of a pump. See Figure 54 in Piping Diagrams.

**NOTE:** In addition to the factory installed Temperature-Pressure Relief Valve (T&P valve) on the water heater, each remote storage tank that may be installed and piped to a water heating appliance must also have its own properly sized, rated and approved Temperature-Pressure Relief Valve installed. See Temperature-Pressure Relief Valve on Page 19.

Call the toll free technical support phone number listed on the back cover of this manual for further assistance in sizing a T&P valve for remote storage tanks.

#### THERMOMETERS (NOT SUPPLIED)

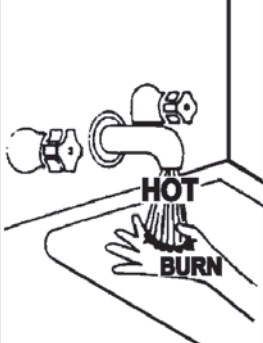
Thermometers are installed in the water piping system as a means of detecting the temperature of the hot water supply at critical points in the system. Field supplied thermometers should be obtained and installed. See Piping Diagrams beginning on Page 58.

#### WATER (POTABLE) HEATING AND SPACE HEATING

1. All water piping components connected to the water heater that are for space heating applications shall be suitable for use with potable water.
2. Toxic chemicals, such as those used for boiler treatment, must NEVER be introduced into this system.
3. The water heaters covered in this manual may never be connected to any existing heating system or component(s) previously used with non-potable water heating appliance.
4. When the system requires water for space heating that exceed safe temperatures at domestic water fixtures a mixing valve must be installed, see Mixing Valves on Page 17.
5. These water heaters cannot be used in space heating applications only.

#### HOTTER WATER CAN SCALD:

Water heaters are intended to produce hot water. Water heated to a temperature which will satisfy space heating, clothes washing, dish washing, cleaning and other sanitizing needs can scald and permanently injure you upon contact. Some people are more likely to be permanently injured by hot water than others. These include the elderly, children, the physically or developmentally disabled. If anyone using hot water fits into one of these groups or if there is a local code or state law requiring a certain temperature water at the hot water tap, then you must take special precautions. In addition to using the lowest possible temperature setting that satisfies your hot water needs, a means such as a mixing valve should be used at the hot water taps used by these people or at the water heater. See Figure 8 in Mixing Valves. Valves for reducing point of use temperature by mixing cold and hot water are also available:

<b>⚠ DANGER</b>	Water temperature over 125°F (52°C) can cause severe burns instantly resulting in severe injury or death.
	Children, the elderly, and the physically or mentally disabled are at highest risk for scald injury.
	Feel water before bathing or showering.
	Temperature limiting valves are available.
	Read instruction manual for safe temperature setting.

Consult a Qualified Installer or Service Agency. Follow manufacturer's instructions for installation of the valves. Before changing the factory setting on the thermostat, read the Temperature Regulation section beginning on Page 34.

## ⚠ WARNING

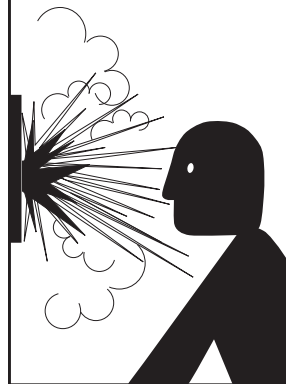
### Toxic Chemical Hazard

- Do not connect to non-potable water system.

#### T&P VALVE DISCHARGE PIPE

## ⚠ WARNING

### Explosion Hazard



- Temperature-Pressure Relief Valve must comply with ANSI Z21.22- CSA 4.4 and ASME code.
- Properly sized temperature-pressure relief valve must be installed in opening provided.
- Can result in overheating and excessive tank pressure.
- Can cause serious injury or death.

This water heater is provided with a properly rated/sized and certified combination temperature - pressure (T&P) relief valve by the manufacturer. See Temperature-Pressure Relief Valve on page 19 for information on replacement and other requirements.

## CAUTION

### Water Damage Hazard

- Temperature-Pressure Relief Valve discharge pipe must terminate at adequate drain.

Install a discharge pipe between the T&P valve discharge opening and a suitable floor drain. Do not connect discharge piping directly to the drain unless a 12 inches (15.2 cm) air gap is provided. To prevent bodily injury, hazard to life, or property damage, the Temperature-Pressure Relief Valve must be allowed to discharge water in adequate quantities should circumstances demand. If the discharge pipe is not connected to a drain or other suitable means, the water flow may cause property damage.

#### T&P VALVE DISCHARGE PIPE REQUIREMENTS:

- Shall not be smaller in size than the outlet pipe size of the valve, or have any reducing couplings or other restrictions.
- Shall not be plugged or blocked.
- Shall not be exposed to freezing temperatures.
- Shall be of material listed for hot water distribution.
- Shall be installed so as to allow complete drainage of both the Temperature-Pressure Relief Valve and the discharge pipe.
- Must terminate a maximum of twelve inches above a floor drain or external to the building. In cold climates, it is recommended that the discharge pipe be terminated at an adequate drain inside the building.
- Shall not have any valve or other obstruction between the Temperature-Pressure Relief Valve and the drain.

# TEMPERATURE REGULATION


## HIGH TEMPERATURE LIMIT CONTROL (ECO)

This water heater is equipped with an ECO (energy cut out) non adjustable high temperature limit switch. The ECO is a normally closed switch that opens (activates) on a rise in temperature. The ECO is located inside the Temperature Probe (two red wires). The ECO switch contacts will open when the water temperature reaches approximately 202°F (94°C) and close at approximately 140°F (49°C).

If the ECO activates (contacts open) due to abnormally high water temperatures in the storage tank, the control system will immediately de-energize the 24 VAC Gas Control Valve and end current heating cycle. The control system will lock out disabling further heating operation. The control system will display the Energy Cut Out (ECO) Fault message on the LCD screen. It is important that a Qualified Service Technician be contacted to determine the reason for ECO activation before resetting the ECO. Once the reason has been determined and corrected the ECO can be reset as follows:

Should the ECO activate, water temperature must drop below 140°F (49°C) before the control system can be reset. Once water temperature has cooled below this point the power supply to water heater must be turned off and on again to reset the control system.

## THERMOSTAT CONTROL



**DANGER**

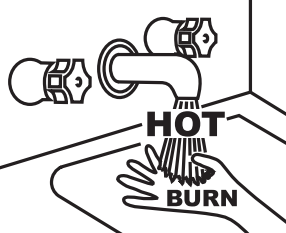
Water temperature over 125°F (52°C) can cause severe burns instantly resulting in severe injury or death.

Children, elderly and the physically or mentally disabled are at highest risk for scald injury.

Feel water before bathing or showering.

Temperature limiting devices such as mixing valves must be installed when required by codes and to ensure safe temperatures at fixtures.

Read instruction manual for safe temperature setting.



Hot water temperatures required for automatic dishwasher and laundry use can cause scald burns resulting in serious personal injury and/or death. Table 11 shows the approximate time-to-burn relationship for normal adult skin.

The temperature at which injury occurs varies with the person's age and duration of exposure. The slower response time of children, the elderly or disabled persons increases the hazards to them. If anyone using hot water provided by the water heater being installed fits into one of these groups or if there is a local code or state law requiring a certain water temperature at the point of use, then special precautions must be taken.

Table 11

Water Temperature °F (°C)	Time for 1st Degree Burn (Less Severe Burns)	Time for Permanent Burns 2nd & 3rd Degree (Most Severe Burns)
110 (43.3)	(normal shower temp.)	
116 (46.7)	(pain threshold)	
116 (46.7)	35 minutes	45 minutes
122 (50)	1 minute	5 minutes
131 (55)	5 seconds	25 seconds
140 (60)	2 seconds	5 seconds
149 (65)	1 second	2 seconds
154 (67.8)	instantaneous	1 second

(U.S. Government Memorandum, C.P.S.C., Peter L. Armstrong, Sept. 15, 1978)

In addition to using the lowest possible temperature setting that satisfies the demand of the application, a mixing valve can be installed at the water heater or at the hot water taps to further reduce system water temperature. See Figure 8 on Page 17.

Never allow small children to use a hot water tap or draw their own bath water. Never leave a child or disabled person unattended in a bathtub or shower.

The water heater should be located in an area where the general public does not have access to set temperatures.

Setting the Operating Set Point at 120°F (49°C) will reduce the risk of scalds. Some States require settings at specific lower temperatures. Check with the code authority having jurisdiction..

The water heaters covered in this manual are equipped with an electronic control system to regulate water temperature inside the storage tank. The control system senses temperature from two factory installed temperature probes, one installed in the top of the storage tank and one installed near the bottom. See Figures 2 and 3 in Features and Components.

The "Operating Set Point" is adjusted to regulate water temperature inside the tank. This is an adjustable user setting in the control system's "Temperature Menu." This and all control system menus are accessed through the UIM (user interface module) located on the front of the water heater. See Figure 38.

The "Operating Set Point" is adjustable from 90°F (32°C) to 160°F (71°C). The factory setting is 120°F (49°C). See Operating Set Point and Differential Adjustment on Page 39 for instructions on how to adjust the Operating Set Point and other settings.

Set the Operating Set Point at the lowest setting which produces acceptable hot water supply. This will always provide the most efficient operation.

## MODULATION

The water heaters covered by this manual are capable of modulating their firing rate. The CCB monitors water temperature in the tank and regulates the firing rate to achieve the target temperature setpoint. The firing rate is dictated by the hot water draw, proximity to the tank temperature setpoint, and various other temperature limitations.

## HIGH TEMPERATURE APPLICATIONS

Higher operating temperatures cause more wear on all water heaters and will decrease the life span of the water heater. Consider installing a small booster water heater for high temperature applications to raise the outlet temperature from the larger primary water heater to the desired point of use temperature. Contact your local distributor or call technical support phone number listed on back cover of this manual for further technical assistance.

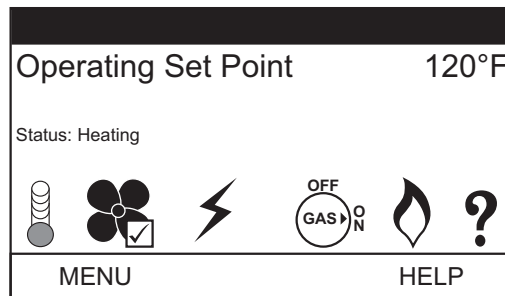


Figure 38

# CONTROL SYSTEM OPERATION

## OVERVIEW

The water heaters covered in this manual are equipped with an electronic control system that regulates water temperature inside the storage tank. Heating cycles and ignition are managed by the control system. The ECO (energy cut out), flame sensor, pressure switches and temperature probes are monitored by the control system. The Combustion Blower, Spark Ignition Transformer, 24 Volt Gas Control Valve are all powered by the control system.

The main components of the control system are a UIM (user interface module) and a CCB (central control board). The UIM is located on the top front side of the water heater. The CCB is mounted on the base of the water heater inside a protective enclosure. See Figure 39. This unit is equipped with an Enable/Disable switch. To operate unit, make sure the switch is set to Enable. See Features and Components beginning on page 10 for location of these and other water heater components.

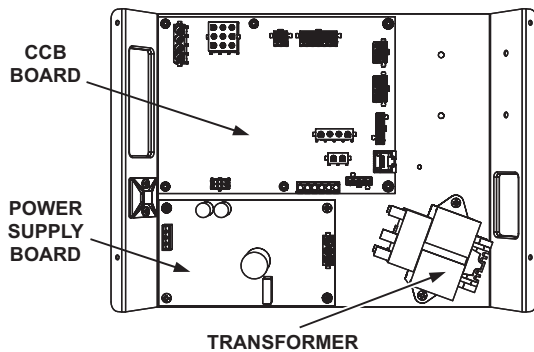


Figure 39

## CONTROL SYSTEM NAVIGATION

All operational information and user settings are displayed and accessed from the UIM. The UIM houses the control system's LCD Touch Display (liquid crystal display). See Figure 40.

### THE DESKTOP SCREEN

During normal operation the control system will display the "Desktop" screen on the LCD Touch Display which is the default screen. The control system will return to the Desktop screen when there are no active Fault or Alert conditions or when there has been no user input for several minutes.

- Manufacturer and water heater model information is displayed in Title Bar at the top of the Desktop screen. Menu titles are displayed in the Title Bar when navigating the control system menus.
- The temperature shown on the Desktop screen is the Operating Set Point. The Operating Set Point is the temperature at which the control system will maintain the water inside the storage tank.
- Beneath the Operating Set Point is the "Status" line. The Status line shows the current operational state of the control system in real time. See Table 13 on page 37 for a description of the various operational states.
- The Desktop screen also displays animated "Status Icons" to convey operational information. See Table 12 on Page 36 for descriptions of the Status Icons.

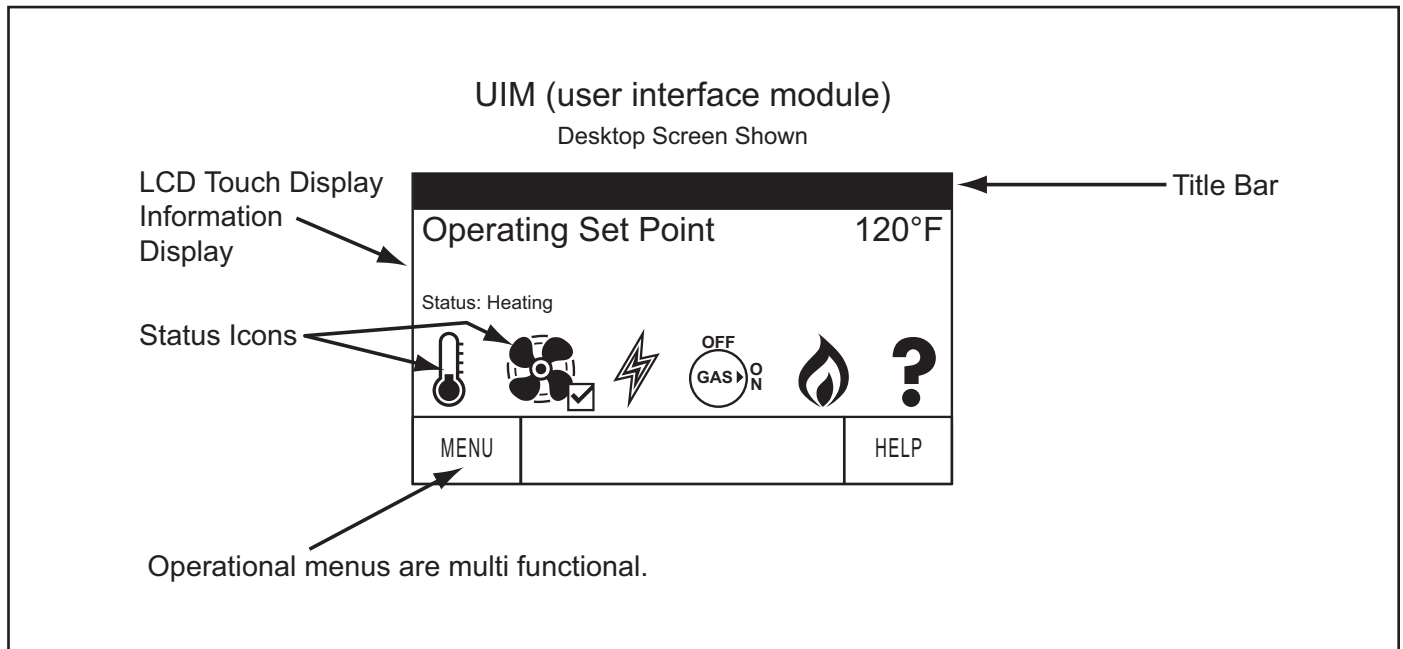











Figure 40

## STATUS ICONS

Status Icons are displayed on the Desktop screen and convey operational and diagnostic information. Icons are described in the table below. See Figure 40 on page 35. Ensure the water heater is properly grounded. Flame sensing requires an adequate earth ground. If the water heater is not properly grounded it will cause Ignition Failure. See Electrical Wiring on page 32.

**Table 12 – Status Icons**

Icon	Description
	Water temperature in the tank has fallen. Shaded area of the animated thermometer icon will rise and fall in response to water temperature in the storage tank as sensed from the Upper and Lower Temperature Probes. See Features and Components section starting on page 10 for location of Temperature Probes.
	Water temperature in the tank has reached the Operating Set Point. The control system enters the Standby mode.
	The control is unable to initiate a heating cycle. This will happen whenever a Fault condition is detected by the control system or when the Enable/Disable switch (located at the base of the water heater) is in disable position.
	The Combustion Blower is being energized.
	The Spark Igniter is being energized. See “Spark Igniter” on page 13 in the Features and Components section.
	The 24 Volt Gas Control Valve is being energized.
	The control system has sensed flame at the Main Burner from the flame sensor. See the “Sequence Of Operation Flow Chart” on page 48 and Figures 2 & 3 in Features and Components.
	The control system has declared a Fault condition and must be inspected/serviced by a Qualified Service Agent. Fault message details can be viewed in the Current Fault menu. Heating operation is disabled (lock out) until the condition that caused the Fault is corrected. Power to the water heater must be cycled off and on at the breaker to reset the control system. <b>NOTE:</b> Cycling power will not reset the control system if the condition that caused the Fault has not been corrected.
	The control system has declared an Alert condition and must be inspected/serviced by a Qualified Service Agent. The water heater will continue to operate during an Alert condition.

## OPERATING STATES

The current operational state of the water heater is displayed on the Desktop screen as the Status. The common operational states are described in the table below.

**Table 13 – OPERATING STATES**

State	Description
Standby	The water heater is not in an active heating cycle. IE: the Tank Temperature is at or above the Operating Set Point minus temperature differential.
Input Verification	The control system is conducting a diagnostic check at the beginning of a heating cycle.
Water Heating Disabled	A Fault condition is detected by the control or when the Enable/Disable switch at the base of the water heater is an open circuit.
Pre-Purge	The Combustion Blower is energized to flush residual flue gases from the combustion chamber prior to ignition.
Spark Igniter Energized	The Igniter is energized and is ready to ensure proper ignition.
Igniter Activation	The 24 Volt Gas Control Valve is energized and opens to allow fuel gas to flow to the Main Burner.
Ignition Verification	The control System is monitoring the flame sensor for the required minimum flame sensing current. Ensure the water heater is properly grounded. Flame sensing Requires an adequate earth ground. If the water heater is not properly grounded it will cause ignition failure.
Inter-Purge	The Combustion Blower is energized to flush residual fuel gas from the combustion chamber after a failed ignition attempt.
Heating	Ignition was successful, flame sensing current has been established. The water in the storage tank is being heated.
Post-Purge	The Combustion Blower is energized to flush residual flue gases from the combustion chamber at the end of a heating cycle.
Fault	The control system has detected a Fault condition. Heating operation is disabled (control system lock out) until the Fault condition is corrected. Water Heating Enable/Disable Switch must be cycled off and on to reset the control system. <b>NOTE:</b> Cycling Water Heating Enable/Disable Switch will not reset the control system if the condition that caused the Fault has not been corrected.
Heating Disabled	The heating is disabled by the Enable/Disable switch located at the base of the water heater.

## CONTROL SYSTEM MENUS

From the Desktop screen pressing the Operational button directly below Menu on the LCD will display the Main Menu. This is where all control system menus are located. The table below describes the control system menus.

**Table 14 – CONTROL SYSTEM MENUS**

Menu	Description
Temperatures	Most commonly accessed menu. Contains the Operating Set Point and Differential user settings.
Heater Status	This menu displays the current state of all pressure switches and the ECO (open/closed). The on/off status of the Combustion Blower, 24 Volt Gas Control Valve, Igniter, Flame Sensor and other monitored water heater components are displayed in this menu.
Display Settings	Temperature units (°F or °C), the LCD appearance (brightness/contrast) and backlight delay user adjustable settings are located in this menu.
Heater Information	Elapsed time of operation, total heating cycle time, heating cycle count, heating on time along with UIM and CCB software revisions can be viewed in this menu.
Current Fault	Displays any current Alert or Fault messages.
Fault History	This control system menu retains a list of the last nine (9) Fault and Alert messages with a time stamp. The newest event will replace the oldest. Fault history memory is cleared after 30 days.
Fault Occurrence	This control system menu retains a running total of how many times each Fault condition has occurred since the water heater was first installed. This data does not clear and cannot be reset. <b>NOTE:</b> if the CCB is replaced during service the fault occurrence historical information for the water heater is lost.
Restore Factory Defaults	This control system feature allows the user to restore control system user settings to their factory default settings. Display Settings preferences ARE NOT changed when factory defaults are restored.
Help Screens	Text based operational and user information explaining how to change user settings, navigate the control system menus and icon descriptions.



## USER SETTINGS & CONTROL SYSTEM MENUS

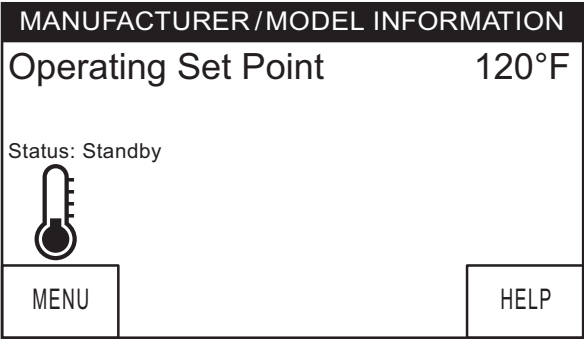
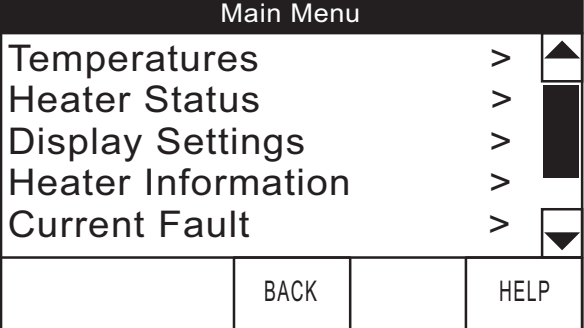
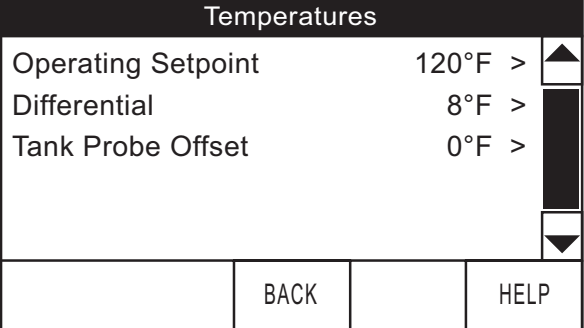
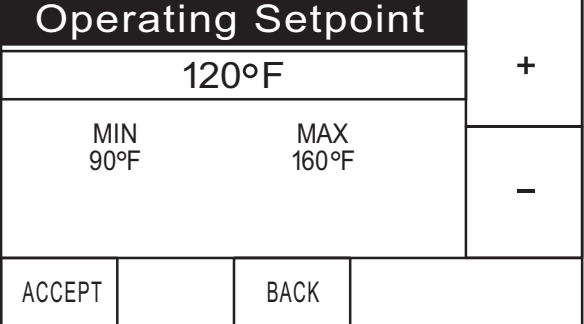
### TEMPERATURES

#### OPERATING SET POINT AND DIFFERENTIAL ADJUSTMENT

The Operating Set Point is adjustable from 90°F (42°C) to 160°F (71°C). The factory setting is 120°F (49°C). The Differential is adjustable from 2° to 20°F. The factory setting is 8°F. These user settings are accessed from the Temperatures menu. These instructions explain how to adjust these settings and navigate the control system.

When the water temperature sensed by the control system from the Temperature Probe reaches the Operating Set Point the control system will end the heating cycle. A heating cycle will be activated again when the sensed water temperature drops below the Operating Set Point minus the Differential setting.

**NOTE:** Set the Operating Set Point to the lowest setting which produces an acceptable hot water supply for most efficient use. Lower Differential settings may cause excessive heating cycles (short-cycling) which can cause premature failure of components such as the Igniter. Set the Differential at the highest setting which produces an acceptable hot water supply to prevent short cycling.

DESCRIPTION/ACTION	DISPLAY
<p>From the Desktop screen, press MENU. The "Main Menu" screen will be displayed.</p>	
<p>The Main Menu is where all control system menus are listed, see Table 14 on page 37 for a complete list and description of control system menus. Use the Up and Down sidebar to view all control system menus from the Main Menu.</p> <p>Press "Temperatures" to access the Temperature menu.</p>	
<p>With the Operating Set Point selected in the Temperatures menu, press "CHANGE" to activate the adjustment mode for this menu item.</p> <p>Press the "Operating Set Point" menu if it is not selected (highlighted in black).</p> <p><b>NOTE:</b> Higher Temperature settings increase wear and operating costs. Set the Operating Set Point to the lowest setting which produces an acceptable hot water supply. This will always provide the most energy efficient operation and longer life.</p>	
<p>Use the "+" and "-" Buttons to change the current setting.</p> <p>Press "ACCEPT" to save the new setting. Press "BACK" to discard changes and return to the previously saved setting.</p> <p><b>NOTE:</b> Use this same procedure to change the Differential setting and other adjustable user settings in the control system menus.</p>	

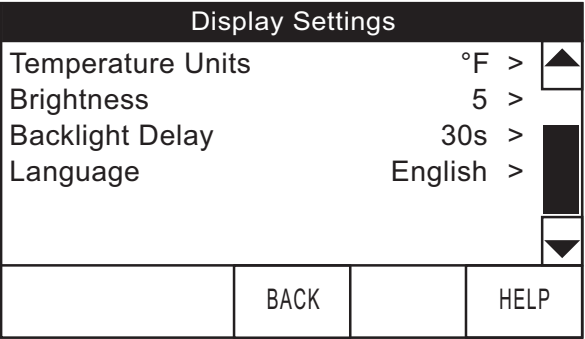
**TEMPERATURES (CONT)**

DESCRIPTION/ACTION	DISPLAY									
<ul style="list-style-type: none"> <li>• <b>Differential</b> - Adjustable user setting that changes the tank temperature differential with a range of 2° to 20°F. The factory setting is 8°F.</li> <li>• <b>Tank Probe Offset</b> - adjustable user setting, range -5° to +5°F (factory setting 0°F).</li> </ul> <p><b>NOTE:</b> These settings should only be used if the hot water supply temperature varies greatly from the Operating Set Point setting.</p> <p>The Tank Probe Offset is used to calibrate control system temperature sensing. This can improve the precision of temperature control in the storage tank and at points of use. This feature can also be used to compensate for building recirculation loops (hot water returning to the storage tank) that may cause the heating cycles to terminate prematurely.</p> <p>Example: If the current sensed temperature from a temperature probe is 120°F (49°C) and the Offset setting is adjusted to a value other than 0°F, the control system would calibrate or “offset” the sensed temperature from the probe and the averaged tank temperature. Heating cycles would be activated and deactivated based on the calibrated (offset) temperature. A -5°F setting results in +5°F hotter water.</p> <p>These settings are adjusted in the same way described for Operating Set Point And Differential Adjustment on page 38.</p>	<div style="border: 1px solid black; padding: 5px;"> <p style="text-align: center; background-color: #333; color: white; margin: 0;">Temperatures</p> <table style="width: 100%; border-collapse: collapse;"> <tr> <td style="width: 70%;">Operating Setpoint</td> <td style="width: 15%;">120°F &gt;</td> <td style="width: 15%; text-align: right;">▲</td> </tr> <tr> <td>Differential</td> <td>8°F &gt;</td> <td style="text-align: right;">■</td> </tr> <tr> <td>Tank Probe Offset</td> <td>0°F &gt;</td> <td style="text-align: right;">▼</td> </tr> </table> <div style="display: flex; justify-content: space-between; margin-top: 5px;"> <span>BACK</span> <span>HELP</span> </div> </div>	Operating Setpoint	120°F >	▲	Differential	8°F >	■	Tank Probe Offset	0°F >	▼
Operating Setpoint	120°F >	▲								
Differential	8°F >	■								
Tank Probe Offset	0°F >	▼								

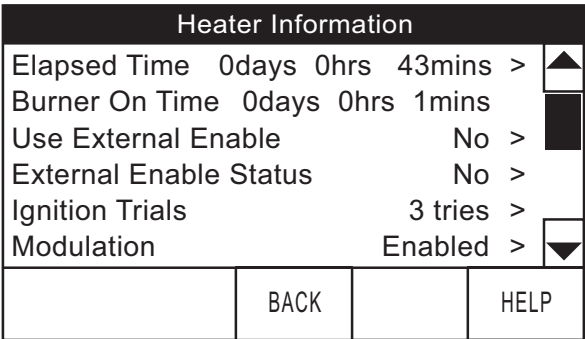
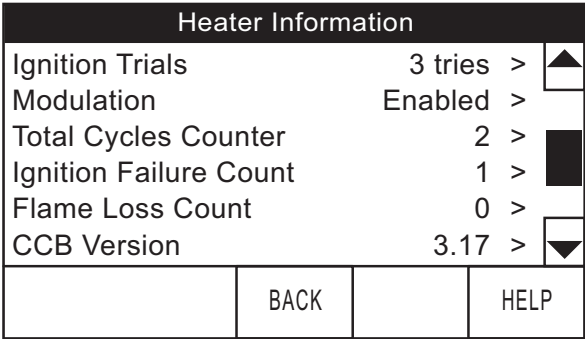
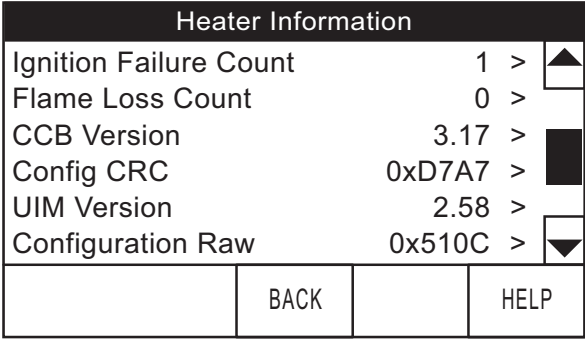
**HEATER STATUS MENU**

DESCRIPTION/ACTION	DISPLAY																											
<p>Press Heater Status from the Main Menu to enter this menu. This menu contains non adjustable operational information. Use the slidebar to navigate the menu.</p> <ul style="list-style-type: none"> <li>• <b>Status</b> - displays the current Operating State, see Table 13 on page 37.</li> <li>• <b>ECO Contact, Blocked Inlet PS, Blocked Outlet PS</b> - displays the current state of the switch contacts; open or closed.</li> <li>• <b>Igniter On, Gas Valve On</b> - displays whether or not the control system is currently energizing these water heater components; yes = energized, no = de-energized.</li> <li>• <b>Flame Detected</b> - displays whether or not the control system has detected Main Burner flame during ignition from the flame sensor.</li> <li>• <b>Blower RPM CMD</b> - displays the controls commanded blower RPM.</li> <li>• <b>Blower RPM</b> - displays the actual blower RPM.</li> </ul> <p><b>NOTE:</b> The menu display is shown with the Enable/Disable switch in Enabled position and the water heater is in Standby mode. When the Enable/Disable switch is in the Disabled position, the water heater will be in “Water Heating Disabled” mode.</p> <p><b>NOTE:</b> The menu displays shown are for informational purposes only. The actual heater display will vary dependent upon the operational state of the water heater.</p>	<div style="text-align: center; margin-bottom: 10px;">Top of Menu</div> <div style="border: 1px solid black; padding: 5px; margin-bottom: 10px;"> <p style="text-align: center; background-color: #333; color: white; margin: 0;">Heater Status</p> <table style="width: 100%; border-collapse: collapse;"> <tr> <td style="width: 70%;">Status:</td> <td style="width: 15%;">Standby</td> <td style="width: 15%; text-align: right;">▲</td> </tr> <tr> <td>ECO Contact</td> <td>Closed</td> <td style="text-align: right;">■</td> </tr> <tr> <td>Blocked Inlet PS</td> <td>Closed</td> <td style="text-align: right;">■</td> </tr> <tr> <td>Blocked Outlet PS</td> <td>Closed</td> <td style="text-align: right;">■</td> </tr> <tr> <td>Igniter On</td> <td>No</td> <td style="text-align: right;">▼</td> </tr> </table> <div style="display: flex; justify-content: space-between; margin-top: 5px;"> <span>BACK</span> <span>HELP</span> </div> </div> <div style="text-align: center;">Bottom of Menu</div> <div style="border: 1px solid black; padding: 5px;"> <p style="text-align: center; background-color: #333; color: white; margin: 0;">Heater Status</p> <table style="width: 100%; border-collapse: collapse;"> <tr> <td style="width: 70%;">Gas Valve On</td> <td style="width: 15%;">No</td> <td style="width: 15%; text-align: right;">▲</td> </tr> <tr> <td>Flame Detected</td> <td>No</td> <td style="text-align: right;">■</td> </tr> <tr> <td>Blower RPM CMD</td> <td>0</td> <td style="text-align: right;">■</td> </tr> <tr> <td>Blower RPM</td> <td>0</td> <td style="text-align: right;">▼</td> </tr> </table> <div style="display: flex; justify-content: space-between; margin-top: 5px;"> <span>BACK</span> <span>HELP</span> </div> </div>	Status:	Standby	▲	ECO Contact	Closed	■	Blocked Inlet PS	Closed	■	Blocked Outlet PS	Closed	■	Igniter On	No	▼	Gas Valve On	No	▲	Flame Detected	No	■	Blower RPM CMD	0	■	Blower RPM	0	▼
Status:	Standby	▲																										
ECO Contact	Closed	■																										
Blocked Inlet PS	Closed	■																										
Blocked Outlet PS	Closed	■																										
Igniter On	No	▼																										
Gas Valve On	No	▲																										
Flame Detected	No	■																										
Blower RPM CMD	0	■																										
Blower RPM	0	▼																										

**DISPLAY SETTINGS**

DESCRIPTION/ACTION	DISPLAY
<p>Press Display Settings from the Main Menu to enter this menu. This menu contains adjustable display options for viewing information on the UIM's LCD screen. Use the Slidebar to navigate the menu.</p> <ul style="list-style-type: none"> <li>• <b>Temperature Units</b> - Adjustable user setting that changes temperature units display to Celsius °C or Fahrenheit °F.</li> <li>• <b>Backlight Delay</b> - Adjustable user setting that determines how long the UIM's LCD backlight remains illuminated after a key has been pressed. Available settings are; Always Off, 10, 30 or 60 seconds and Always On.</li> <li>• <b>Contrast</b> - Adjustable user setting to adjust the UIM's LCD screen contrast between text and background.</li> </ul> <p><b>NOTE:</b> These settings are adjusted in the same way described for the Operating Set Point And Differential Adjustment on page 38.</p>	

**HEATER INFORMATION**

DESCRIPTION/ACTION	DISPLAY
<p>Press Heater Information from the Main Menu to enter this menu. This menu contains non adjustable operational information.</p> <ul style="list-style-type: none"> <li>• <b>Elapsed Time</b> - Total accumulated time the control system (water heater) has been energized.</li> <li>• <b>Burner On Time</b> - Total accumulated time the control system has been in the heating operating state; burner run time.</li> <li>• <b>Total Cycle Count</b> - Total accumulated count of heating cycles.</li> <li>• <b>CCB Version</b> - Software version for central control board.</li> <li>• <b>Config CRC</b> - Verifies the configuration key matches the CCB programming.</li> <li>• <b>UIM Version</b> - Software version for user interface module.</li> <li>• <b>Use External Enable</b> - Enables/Disables the external enable circuit.</li> <li>• <b>External Enable Status</b> - Displays whether or not the external enable circuit has been activated.</li> <li>• <b>Ignition Trials</b> - Displays the number of ignition trials allowed.</li> </ul> <p><b>NOTE:</b> Historical data is stored in the configuration key. If this "key" is replaced during servicing the historical data will be lost. The data stored in the new configuration key will no longer reflect the entire history of the water heater.</p> <p>The Elapsed Time, Burner On Time and Cycle Count indicate age, usage and wear.</p> <p>If the Cycle Count per day is high (divide cycle count by days to determine cycles per day) or the cycle duration is short (determine burner on time total minutes, divide burner on time total minutes by cycle count) consider raising the Differential setting to avoid short cycling and excessive component wear, see Operating Set Point And Differential Adjustment on page 38.</p> <p>This historical data can also be used to assist facilities managers in forecasting planned replacement of equipment to help avoid lengthy and costly hot water supply interruptions.</p>	 <p style="text-align: center;"><b>Bottom of Menu</b></p>  

**CURRENT FAULT**

DESCRIPTION/ACTION	DISPLAY
<p>Press Current Fault from the Main Menu and press the Operational Button under "SELECT" to enter this menu. This menu contains non adjustable operational information. Use the Slidebar to navigate the menu.</p> <p>This menu contains the current Fault or Alert error message. The time the Fault or Alert message occurred appears directly below. A brief description of what causes the particular Fault or Alert condition appears below that. Pressing "ADVANCED" will give more detailed service information and a list of possible causes for the Fault or Alert condition. See "Fault And Alert Messages" beginning on Page 50 for more detailed information and diagnostic procedures.</p> <p>If there is no Fault or Alert condition active this menu will not contain any information, "(none)" will be shown next to Current Fault in the Main menu.</p>	<div style="border: 1px solid black; padding: 10px;"> <p style="text-align: center;"><b>Blocked Exhaust</b> 0 days 0 hrs 0 mins ago Error Code: A8-1201</p> <div style="display: flex; justify-content: space-between; align-items: center;"> <div style="display: flex; align-items: center;"> <div> <p>Restriction in exhaust pipe. Check exhaust pipe and termination for blockage.</p> </div> </div> <div style="text-align: right;"> </div> </div> <p style="text-align: center; margin-top: 10px;">Press the Advanced button for</p> <div style="display: flex; justify-content: space-around; margin-top: 10px;"> <span>BACK</span> <span>ADVANCED</span> </div> </div>

**FAULT HISTORY**

DESCRIPTION/ACTION	DISPLAY
<p>Press "Fault History" from the Main Menu to enter this menu. This menu contains non adjustable operational information. Use the Slidebar to navigate the menu.</p> <p>This menu contains a list of the last nine (9) Fault and Alert messages with a time stamp. The newest event will replace the oldest.</p> <p>Press the Fault to view details for each Fault or Alert message stored.</p>	<div style="border: 1px solid black; padding: 10px;"> <p style="text-align: center;"><b>Fault History</b></p> <ol style="list-style-type: none"> <li>1: Upper Temp Probe (Open) (47) &gt; <span style="float: right;">▲</span> 0 days 2 hrs 37 mins ago &gt; <span style="float: right;">■</span></li> <li>2: Hardware Failure (1A) &gt; <span style="float: right;">▲</span> 0 days 2 hrs 37 mins ago &gt; <span style="float: right;">■</span></li> <li>3: Upper Temp Probe (Open) (47) &gt; <span style="float: right;">▲</span> 0 days 2 hrs 40 mins ago &gt; <span style="float: right;">▼</span></li> </ol> <div style="display: flex; justify-content: space-around; margin-top: 10px;"> <span>BACK</span> <span>HELP</span> </div> </div>

**FAULT OCCURRENCE**

DESCRIPTION/ACTION	DISPLAY															
<p>Press Fault Occurrence from the Main Menu to enter this menu. This menu contains non adjustable operational information. Use the Slidebar to navigate the menu.</p> <p>This menu contains a running total of how many times each Fault condition has occurred since the water heater was first installed.</p> <p><b>NOTE:</b> Historical data is stored in the configuration key. If this "key" is replaced during servicing the historical data will be lost. The data stored in the new configuration key will no longer reflect the entire history of the water heater.</p>	<div style="border: 1px solid black; padding: 10px;"> <p style="text-align: center;"><b>Fault Occurrence</b></p> <table style="width: 100%; border-collapse: collapse;"> <tr> <td style="padding: 2px;">Ignition Failure</td> <td style="text-align: right; padding: 2px;">0 &gt;</td> <td style="text-align: right; padding: 2px;">▲</td> </tr> <tr> <td style="padding: 2px;">ECO</td> <td style="text-align: right; padding: 2px;">0 &gt;</td> <td style="text-align: right; padding: 2px;">■</td> </tr> <tr> <td style="padding: 2px;">Blocked Intake Air</td> <td style="text-align: right; padding: 2px;">1 &gt;</td> <td style="text-align: right; padding: 2px;">▲</td> </tr> <tr> <td style="padding: 2px;">Blocked Exhaust</td> <td style="text-align: right; padding: 2px;">1 &gt;</td> <td style="text-align: right; padding: 2px;">■</td> </tr> <tr> <td style="padding: 2px;">External Input</td> <td style="text-align: right; padding: 2px;">0 &gt;</td> <td style="text-align: right; padding: 2px;">▼</td> </tr> </table> <div style="display: flex; justify-content: space-around; margin-top: 10px;"> <span>BACK</span> <span>HELP</span> </div> </div>	Ignition Failure	0 >	▲	ECO	0 >	■	Blocked Intake Air	1 >	▲	Blocked Exhaust	1 >	■	External Input	0 >	▼
Ignition Failure	0 >	▲														
ECO	0 >	■														
Blocked Intake Air	1 >	▲														
Blocked Exhaust	1 >	■														
External Input	0 >	▼														

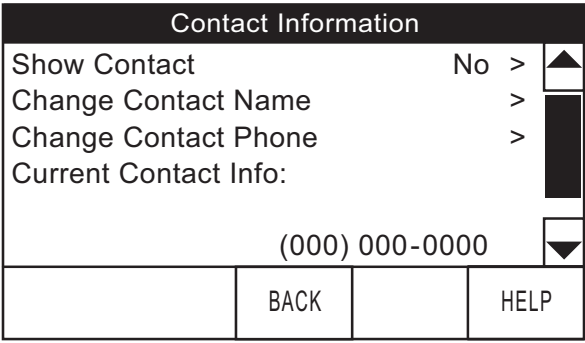
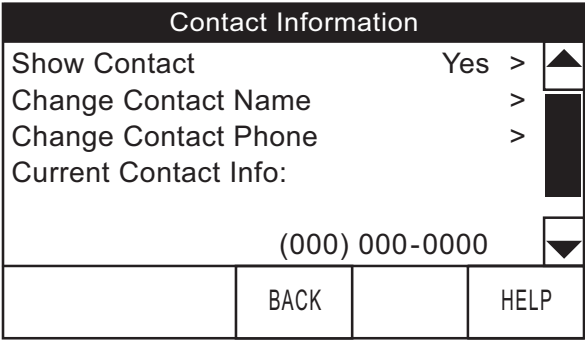
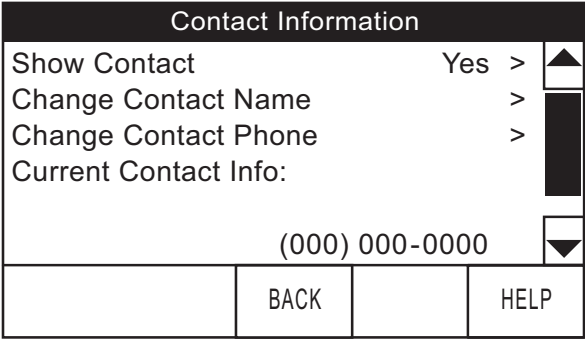
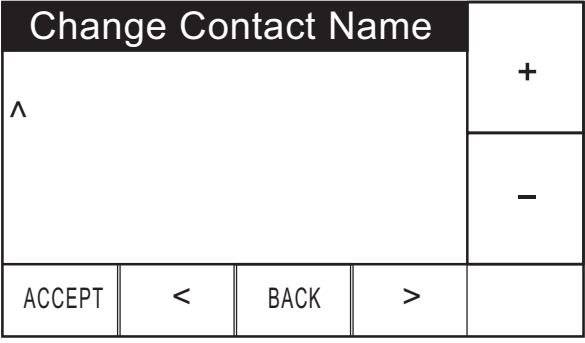

**RESTORE FACTORY DEFAULTS**

DESCRIPTION/ACTION	DISPLAY
<p>Press Restore Factory Defaults from the Main Menu to enter this menu.</p> <p>To restore the adjustable user settings to their factory default settings press "YES." The display will show text confirming the factory default settings have been restored.</p> <p>Press NO to exit the Restore Factory Defaults menu.</p>	<div style="border: 1px solid black; padding: 10px;"> <p style="text-align: center;"><b>Restore Defaults</b></p> <div style="display: flex; justify-content: space-between; align-items: center;"> <div style="display: flex; align-items: center;"> <div> <p>Are you sure you want to restore the system to the factory defaults?</p> </div> </div> </div> <div style="display: flex; justify-content: space-around; margin-top: 10px;"> <span>Yes</span> <span>No</span> </div> </div>



**SERVICE CONTACT INFORMATION**

The control system has a discrete menu that Installing contractors and/or service agents can access to enter contact information for their customers. This contact information will be displayed with all Fault and Alert messages.

DESCRIPTION/ACTION	DISPLAY
<p>From the Desktop Screen (see Figure 40 on page 36) press and hold down the middle (unmarked) Operational Button for 30 seconds and then release it. It is located between the "MENU" and "HELP" buttons.</p> <p>This will launch a discrete menu where personalized contact information can be entered.</p> <p>Using the Sidebar select (highlighted in black) the "Show Contact" menu item.</p> <p>Press "ACCEPT" to activate the adjustment mode for this parameter.</p>	 <p>The screenshot shows a menu titled "Contact Information". The first item is "Show Contact" with a value of "No" and a right arrow. Below it are "Change Contact Name", "Change Contact Phone", and "Current Contact Info:". The phone number is "(000) 000-0000". At the bottom are "BACK" and "HELP" buttons.</p>
<p>Press the "+" and "-" Buttons to change the setting from "No" to "Yes" and press "ACCEPT" to save the new setting.</p> <p><b>NOTE:</b> The Access Code at the bottom of the Service Contact Information screen is for manufacturing engineering purposes only. There are no user settings or information accessed through this menu item.</p>	 <p>The screenshot shows the same "Contact Information" menu, but the "Show Contact" value is now "Yes".</p>
<p>Press the "Change Contact Name" to enter this menu.</p>	 <p>The screenshot shows the "Contact Information" menu with "Change Contact Name" selected and highlighted in black.</p>
<p>Press the "+", "-", "&lt;", and "&gt;" icons to enter your name or the name of your company.</p> <p>When finished press "ACCEPT" to save the new Contact Name. The control system will return to the discrete menu.</p> <p>Follow these same instructions to change the Contact Phone Number.</p>	 <p>The screenshot shows a screen titled "Change Contact Name". It has a large input field with a cursor and the letter "A". To the right are "+" and "-" buttons. At the bottom are "ACCEPT", "&lt;", "BACK", and "&gt;" buttons.</p>
<p>When the new Contact Name and Contact Phone number have both been updated, press "BACK" to return to the Desktop screen.</p>	 <p>The screenshot shows the "Contact Information" menu with "Show Contact" set to "Yes". The "Current Contact Info:" now displays "YOURCOMPANYNAMEHERE" and "(123) 456-7890".</p>

# START UP

## START UP CONDITIONS

### SMOKE/ODOR

It is not uncommon to experience a small amount of smoke and odor during the initial start-up. This is due to burning off of oil from metal parts, and will disappear in a short while.

## CAUTION

**Improper installation and use may result in property damage.**

- Avoid water heater damage.
- Install thermal expansion tank or device if necessary.
- Contact qualified installer or service agency.

## PRIOR TO START UP

Installation and start up of this water heater requires abilities and skills equivalent to that of a licensed tradesman in the field involved, see Qualifications on page 8.

**DO NOT USE THIS APPLIANCE IF ANY PART HAS BEEN EXPOSED TO FLOODING OR WATER DAMAGE.** Immediately call a qualified service technician to inspect the water heater and to make a determination on what steps should be taken next.

Light the water heater in accordance with the Lighting and Operation Instruction label on the water heater and in this manual on page 46.

The water heaters covered by this manual are equipped with an electronic control system (see page 36) which automatically sequences the Combustion Blower, pre and post purging of the combustion chamber, the spark transformer, the 24 Volt Gas Control Valve, Main Burner Ignition, and flame sensing. The control system will lock out after three unsuccessful ignition attempts.

Before attempting start up, thoroughly study and familiarize yourself with the exact Sequence of Operation. See the Sequence of Operation Flow Chart on page 49. Ensure the water heater is properly grounded. Flame sensing requires an adequate earth

ground. If the water heater is not properly grounded it will cause Ignition Failure. See Electrical Wiring on page 33.

Be certain that the water heater is full of water, that air is purged from the gas and water lines and that there are no leaks in the gas and water lines. Ensure all inlet water valves are open.

## FILLING THE WATER HEATER

## CAUTION

**Property Damage Hazard**

- Avoid water heater damage.
- Fill tank with water before operating.

Never use this water heater unless it is completely full of water. To prevent damage to the tank, the tank must be filled with water. Water must flow from the hot water faucet before turning ON gas to the water heater.

To fill the water heater with water:

1. Locate the drain valve at the base of the water heater behind the access panel. See Features and Components beginning on Page 11.
2. Close the water heater drain valve by turning the handle to the right (clockwise).
3. Open the cold water supply valve to the water heater. NOTE: The cold water supply valve must be left open when the water heater is in use.
4. To insure complete filling of the tank, allow air to exit by opening the nearest hot water faucet. Allow water to run until a constant flow is obtained. This will let air out of the water heater and piping.
5. Check all water piping and connections for leaks. Repair as needed. See Gas Line Leak Testing on Page 32.

## INITIAL START UP

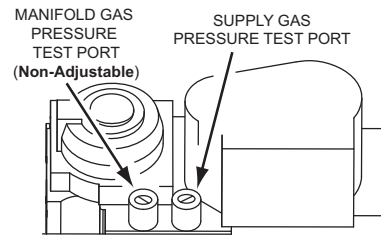
### REQUIRED TEST EQUIPMENT

- One U-tube manometer, recommended ranges; 0-14" W.C. (0-3.5 kPa) and 0-35" W.C. (0-8.7 kPa) or pressure gauges.
- One digital manometer can be used in place of U-tube manometers or pressure gauges. Recommended ranges; -14.00 to +14.00" W.C. (0-3.5 kPa) resolution 0.01" W.C. and 0-35" W.C. (0-8.7 kPa) resolution 0.10" W.C.

**NOTE:** All test equipment must be acclimated to ambient temperature before calibration and use.

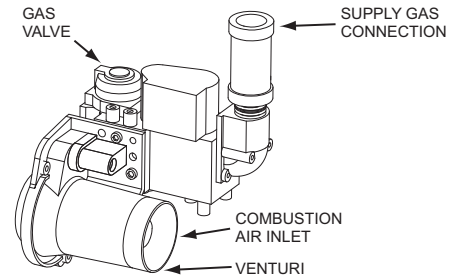
### PREPARATION

1. Using the control system menus, change the Operating Set Point to the lowest temperature setting, see Operating Set Point And Differential Adjustment on page 39.
2. Turn the water heater's Enable/Disable switch to the "Disabled" position.
3. Close the manual gas shut off valve, see Figure 37 on page 31.
4. Wait five (5) minutes for any residual gas to clear.
5. Connect the manometer to the supply gas pressure port on the gas control valve, see Figure 41 and Figure 42.  
On the water heaters covered by this manual there are test ports for supply and manifold gas pressure readings on the gas control valve. Using a small flat tip pocket screw driver - open the needle valve inside the supply gas pressure test port one full turn only; turn the needle valve screw counter-clockwise to open the valve. Slide the manometer sensing tube over the top of the test port, see Figure 41 and Figure 42.
6. Open the Main Gas Shutoff Valve.
7. Measure and record the supply gas pressure, this is a "static" supply gas pressure reading; while the water heater is not firing. Adjust supply gas pressure as necessary, see Gas Supply Systems on Page 17.



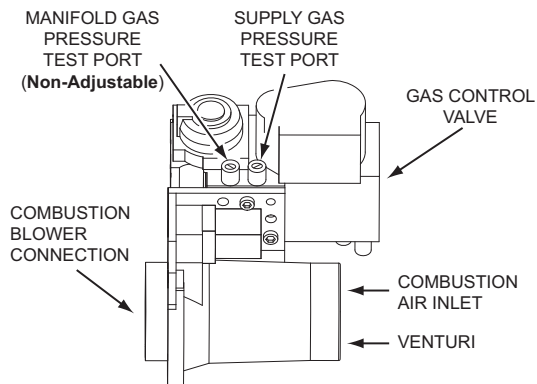
GAS CONTROL VALVE TOP DETAIL VIEW

Figure 42



GAS CONTROL VALVE / VENTURI ASSEMBLY SIDE VIEW

Figure 43



GAS CONTROL VALVE / VENTURI ASSEMBLY TOP VIEW

Figure 41

# LIGHTING THE WATER HEATER

## LIGHTING & OPERATION LABELS

The instruction label below is affixed to the water heater's covered by this manual at the factory and must be followed when lighting and operating the water heater.

### FOR YOUR SAFETY READ BEFORE LIGHTING



**WARNING:** If you do not follow these instructions exactly, a fire or explosion may result causing property damage, personal injury or loss of life.



**BEFORE OPERATING: ENTIRE SYSTEM MUST BE FILLED WITH WATER AND AIR PURGED FROM ALL LINES.**

A. This appliance does not have a pilot. It is equipped with an ignition device which automatically lights the burner. **Do not try to light the burner by hand.**

B. **BEFORE OPERATING** smell all around the appliance area for gas. Be sure to smell next to the floor because some gas is heavier than air and will settle on the floor.

#### WHAT TO DO IF YOU SMELL GAS

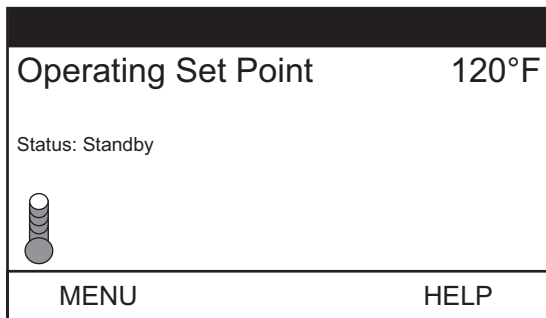
- Do not try to light any appliance.
- Do not touch any electric switch; do not use any phone in your building.
- Immediately call your gas supplier from a neighbor's phone. Follow the gas supplier's instructions.

● If you cannot reach your gas supplier, call the fire department.

C. Use only your hand to push in the control buttons. Never use tools. If the control buttons will not push in, don't try to repair them, call a qualified service technician. Force or attempted repair may result in a fire or explosion.

D. Do not use this appliance if any part has been under water. Immediately contact a qualified installer or service agency to replace a flooded water heater. Do not attempt to repair the unit. It must be replaced!

### OPERATING INSTRUCTIONS



1. **STOP!** Read the safety information above on this label.
2. Set the Enable / Disable switch at the base of the water heater to the Enable position.
3. Set the thermostat to the lowest setting.
4. Set the Enable / Disable switch at the base of the water heater to the Disable position.

5. This appliance is equipped with a device which automatically lights the burner. **DO NOT TRY TO LIGHT THE BURNER BY HAND.**

6. Wait five (5) minutes to clear out any gas. If you then smell gas, **STOP!** Follow "B" in the safety information above on this label. If you don't smell gas, go to the next step.

7. Turn on all electrical power to the appliance.

8. Set the Enable / Disable switch at the base of the water heater to the Enable position.

9. Set the thermostat to the desired setting.

**CAUTION: Hotter water increases the risk of scald injury. Consult the instruction manual before changing temperature.**

10. If the appliance will not operate, follow the instructions "TO TURN OFF GAS TO APPLIANCE" and call your technician or gas supplier.

**WARNING: TURN OFF ALL ELECTRIC POWER BEFORE SERVICING.**

### TO TURN OFF GAS TO APPLIANCE

1. Set the thermostat to the lowest setting.
2. Set the Enable / Disable switch at the base of the water heater to the Disable position.
3. Turn off all electrical power to the appliance if service is to be performed.



## CHECKING THE FIRING RATE

Follow these instructions to determine the actual firing rate of the water heater:

**NOTE:** The heaters covered by this manual are capable of modulating their firing rate. The firing rate should be checked with the heater operating at its full firing rate.

1. Ensure there are no other gas fired appliances connected to the gas meter firing during this test.
2. Contact the gas supplier to determine the heating value, in Btu per cubic foot, of the gas supply.
3. Connect a manometer to the supply gas pressure tap. Follow the instructions for Start Up beginning on Page 44.
4. Start the water heater and ensure it is firing.
5. Check the supply gas pressure, refer to Supply Gas Systems on page 17 for correct pressure.
6. Locate the gas meter serving the water heater.
7. Time how long (in seconds) it takes for one cubic foot of gas to be used while the water heater is firing with a stop watch.
8. Use the formula below to "clock" the gas meter and determine the actual firing rate of the water heater based on the heating value (Btu per cubic foot) of the gas supply:

$$\frac{3600}{T} \times H = \text{Btu/hr}$$

Example:

$$\frac{3600}{12.6} \times 1050 = 300,000 \text{ Btu/hr (87.9 kW)}$$

- 3600 = seconds in one hour.
- T = time, in seconds, to burn one cubic foot of gas.
- H = heating value of gas in Btu per cubic foot.
- Btu/hr = actual firing rate of the water heater.

**NOTE:** 1050 Btu per cubic foot is a standard value for natural gas. Standard propane gas Btu content is 2500 Btu per cubic foot. Btu values may change in certain areas and at high elevations. Check with the local gas utility company.

## TO TURN OFF GAS SUPPLY

1. Change the Operating Set Point to the lowest temperature setting, see Operating Set Point And Differential Adjustment on page 39.
2. When the water heater has completed its shut down sequence and enters the standby mode, turn the water heater's Enable/Disable switch to the "Disable" position. When in the "Disable" position the switch only removes electrical power from the gas control valve so that water heating is disabled. The display, CCB, and other electrical components will still be energized and the display will read "Water Heating Disabled".
3. Close Main Gas Shutoff Valve, see Figure 37 on page 31

## GAS INPUT RATE

The gas input rate of this water heater is affected by several environmental factors such as:

- The heating value of the gas
- The air and gas densities (which vary widely due to barometric pressure and temperature changes)
- Venting installations (pipe diameter, length and fittings)
- Altitude

When measuring the input rate these factors should be incorporated into the calculations. Also measure the gas consumption over a sufficiently long time to obtain an accurate gas consumption rate (e.g. 3-5 minutes, not one revolution of the meter needle).

Long vents and each additional elbow, inherently reduce the gas input rate due to increased resistance to moving combustion air and flue gases. The approximate maximum/minimum input for all models shown in Figure 44.

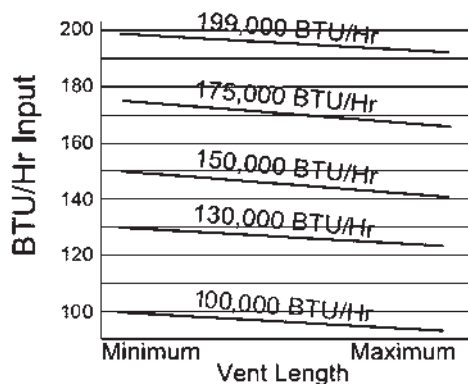



Figure 44

## HIGH ALTITUDE INSTALLATIONS

**! WARNING**

**Breathing Hazard - Carbon Monoxide Gas**



- Special consideration must be taken with installations above 7,700 feet (2,347 m).
- Please contact an A. O. Smith qualified service agent to obtain the proper setup and instructions before lighting.
- Failure to implement the proper setup will result in improper and inefficient operation of the appliance resulting in production of increased levels of carbon monoxide gas in excess of the safe limits which could result in serious personal injury or death.

**Breathing carbon monoxide can cause brain damage or death. Always read and understand instruction manual.**

This high efficiency water heater is certified for use without modification for an altitude of 7,700 feet (2,347 m). Consult the factory for installation at altitudes over 7,700 feet (2,347 m).

Some gas utility companies derate their gas for altitude, making it unnecessary to install high altitude orifices. Call the local gas or utility company to verify BTU content.

Due to the input rate reduction at high altitudes, the output rating of the water heater is also reduced and should be compensated for in the sizing of the equipment for applications. See Planning the Vent System on Page 23.

# TROUBLESHOOTING

## INSTALLATION CHECKLIST

The list below represents some of the most critical installation requirements that, when overlooked, often result in operational problems, down time and needless parts replacement. This is not a complete list. Before performing any troubleshooting procedures use the list below to check for installation errors. Costs to correct installation errors are not covered under the limited warranty. Ensure all installation requirements and instructions in this manual have been maintained and followed.

### WATER HEATER LOCATION

1. Ensure proper clearances to combustibles are maintained and there is sufficient room to service the water heater. See Locating the Water Heater section on pages 15-16.
2. Ensure the area is free of corrosive elements and flammable materials. See Combustion and Ventilation Air on page 16.

### VENTING

1. Ensure the intake air and/or vent (exhaust) piping is the correct size for the installed length. See the Vent Pipe Installation section beginning on Page 22.
2. Ensure the maximum equivalent feet of pipe has not been exceeded for the intake air and/or vent pipe. See the Vent Pipe Installation section beginning on Page 22.
3. Ensure the maximum number of elbows has not been exceeded in the intake air and/or vent pipe. See the Vent Pipe Installation section beginning on Page 22.
4. Ensure all exterior clearances for the intake air, vent and concentric terminations are maintained. These clearances and those cited by local and national codes must be maintained. See Horizontal Vent Terminal Installation on page 25, Vertical Vent Termination on page 26, and Concentric Vent Installation on page 29.
5. Ensure the integrated filter in air intake at the water heater is clean and free of debris. See Integrated Filter Preventative Maintenance on page 54.

### GAS SUPPLY AND PIPING

1. Ensure a supply gas regulator has been installed for each water heater. See Supply Gas Regulator on page 17.
2. Ensure the supply gas line to each water heater meets the minimum supply gas line size requirements. See Supply Gas Systems on page 17 and Supply Gas Line Installation beginning on Page 31.

### CONDENSATE DRAIN

1. Ensure the condensate drain is properly connected to the exhaust elbow on the water heater and draining freely to a suitable floor drain. See Condensate Drain Installation on page 31.

### ELECTRICAL CONNECTIONS

1. Ensure the power supply connections to the water heater are polarity correct. See the requirements for the Power Supply on page 18 and Electrical Wiring on page 33.
2. Ensure the water heater is properly grounded. Flame sensing requires an adequate earth ground. If the water heater is not properly grounded it will cause Ignition Failure. See Electrical Wiring on Page 33.

## SEQUENCE OF OPERATION

Read the Sequence of Operation below before attempting to correct any operational problems. Refer to the Features and

Components beginning on page 11 for the location of various water heater components described below. See the Sequence of Operation Flow Chart on page 49 also.

1. When the control system is first powered, during boot up, the blower will run momentarily and stop, and the control system will display water heater model information during initialization. After a few moments the control system LCD which is part of the UIM (user interface module) will display the default screen known as the Desktop screen.
2. If the control system determines that the actual water temperature inside the tank is below the programmed Operating Set Point minus the Differential setting, a heating cycle is activated.
3. The control system then performs selected diagnostic system checks. This includes confirming the blocked exhaust, blocked intake and ECO (energy cut out) switch contacts are closed.
4. If all diagnostic checks are successfully passed, the control system energizes the Combustion Blower for pre-purge.
5. The control system energizes the Spark Ignition Transformer.
6. After a few seconds, the control system energizes the 24V Gas Control Valve allowing gas to flow to the Main Burner.
7. The control system monitors the flame sensor to confirm a flame is present at the Main Burner. If a flame is not verified during the ignition trial period the control system will try for ignition up to two more times. If flame can not be verified after three trials for ignition, the control system will lock out and display the Ignition Failure Fault message.
8. If a flame is verified, the control system will enter the heating mode where it will continue heating the water until the Operating Set Point is reached. At this point, the control system will de-energize the 24 V Gas Control Valve and enter the post-purge cycle (approximately 30 seconds).
9. The water heaters covered by this manual are capable of modulating their firing rate. The firing rate is dictated by the hot water draw and various other temperature limitations.
10. The Combustion Blower will run for the duration of the post-purge cycle to purge the water heater of all combustion gases. When the post-purge cycle is complete, the blower is de-energized and will coast to a stop.
11. The control system now enters the standby mode while continuing to monitor the internal storage tank water temperature and the state of other system devices. If the tank temperature drops below the Operating Set Point minus the Differential setting, the control will automatically return to Step 2 and repeat the operating cycle.

## SEQUENCE OF OPERATION FLOW CHART

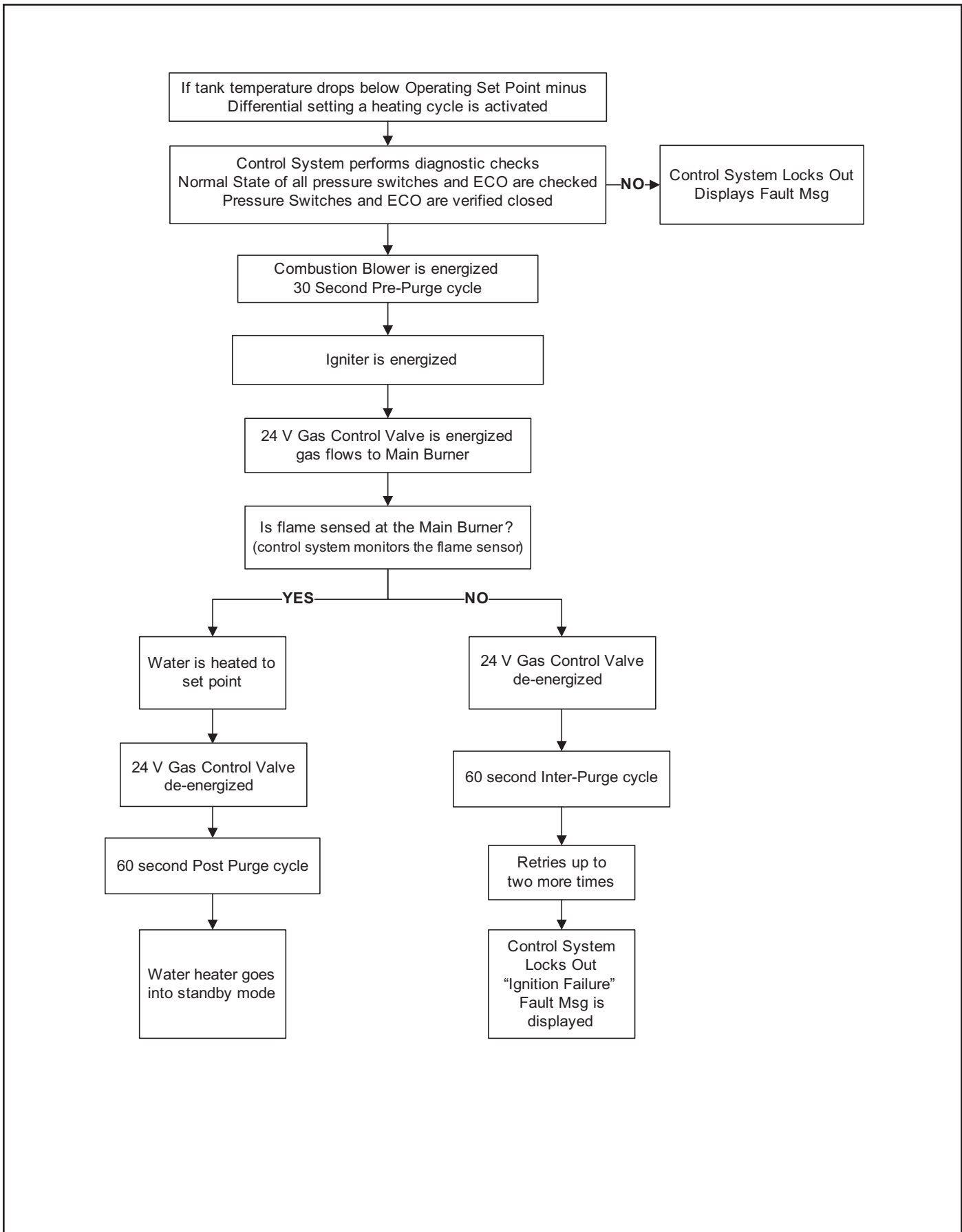


Figure 45



## OPERATIONAL PROBLEMS

	 <b>WARNING</b>
	<p>Read and understand this instruction manual and the safety messages herein before installing, operating or servicing this water heater.</p> <p>Failure to follow these instructions and safety messages could result in death or serious injury.</p> <p>This manual must remain with the water heater.</p>

This section of the manual is intended to be an aid in correcting common operational problems, it is not all inclusive. The installer may be able to observe and correct certain problems which might arise when the water heater is first put into operation or when it is re-fired after a prolonged shutdown. However, only qualified service technician should perform any service procedures on the water heater.


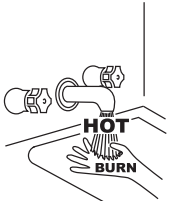
**NOTE:** Call the technical support phone number listed on the back cover of this manual for further technical assistance or to locate a qualified service technician in your area.

### ROUGH STARTING, ROUGH OPERATION

	 <b>WARNING</b>
	<b>Fire and Explosion Hazard</b>
<ul style="list-style-type: none"> <li>Do not use water heater with any gas other than the gas shown on the rating plate.</li> <li>Excessive gas pressure to gas control valve can cause serious injury or death.</li> <li>Turn off gas lines during installation.</li> <li>Contact a qualified installer or service technician for installation and service.</li> </ul>	

- Undersized supply gas line (low volume of supply gas).
- Low Gas Pressure.
- Excessive supply gas pressure.
- Excessive manifold (offset) gas pressure.
- Incorrect Fuel Type
- Vent (exhaust) gas recirculation at the vent and intake air pipe terminations on Direct Vent installations.
- Excessive equivalent lengths of intake air and/or vent (exhaust) piping installed.
- Clogged/blocked air intake integrated filter.
- Clogged/blocked the Main Burner.

### MOMENTARY IGNITION

 <b>CAUTION</b>	
<b>Burn Hazard</b>	
	<ul style="list-style-type: none"> <li>The combustion chamber and burner sleeve and housing become very hot during operation.</li> <li>Do not reach into the burner housing or combustion chamber if the water heater is still hot.</li> <li>Allow the water heater to cool and always use gloves when handling the main burner.</li> </ul>

If the Main Burner ignites momentarily but does not sustain ignition allow the water heater to try to ignite up to two more times until control system locks out and the Ignition Failure Fault message is displayed on the control system's LCD. If the water heater is experiencing rough starts - see Rough Starting, Rough Operation on this page. For momentary ignition problems without rough starting check the following:

- Undersized supply gas line (low volume of supply gas).
- Low Gas Pressure
- See the list of possible causes and things to check and repair for the Ignition Failure Fault message.
- Clogged/blocked air intake integrated filter.
- Clogged/blocked Main Burner.

### NOT ENOUGH OR NO HOT WATER

- No power to the water heater, check breaker, fuses.
- Enable/Disable switch in "disabled" position. Set to enable to allow unit to operate.
- Hot water supply valve(s) to fixtures closed.
- Operating Set Point is set too low, Differential setting is set too high.
- Temperature Probe Offset setting are causing the heating cycles to terminate prematurely.
- The heating capacity of the water heater has been exceeded, the water heater is unable to meet demand.
- Colder incoming water temperature lengthening the time required to heat water to desired temperature.
- Hot water piping leaks, open faucets, water heater drain valve leaking or open. See Leakage Checkpoints on Page 53.
- Sediment or lime scale accumulation may be affecting water heater operation.

### WATER IS TOO HOT

- Operating Set Point is set too high. See Operating Set Point and Differential Adjustment on Page 39.
- Temperature Probe Offset settings improperly set. See Operating Set Point and Differential Adjustment on Page 39.
- If installed check Thermostatic Mixing Valve settings. See Mixing Valves on Page 18.
- Lime build-up on temperature probes.

### NOISY OPERATION

- Normal operating noise of electrical components; Combustion Blower, transformer hum, relay contact closure.

### REPLACEMENT PARTS

Replacement parts may be ordered from the manufacturer, authorized service agencies or distributors. When ordering parts be sure to have the complete water heater Model Number, Serial Number and Series Number available. This information can be found on the rating plate affixed to the water heater.

For more information or technical support call the technical support phone number listed on the back cover of this manual.

## FAULT AND ALERT CONDITIONS

### FAULT CONDITIONS

When the control system declares a Fault condition it will display a Fault message on the control system's LCD with an exclamation "!" mark. The control system will lock out and disable heating operation until the condition is corrected. The water heater must be serviced by a qualified service technician before operation can be restored.

### ALERT CONDITIONS

When the control system declares an Alert condition it will display an Alert message on the control system's LCD with a question "?" mark. The water heater will continue to operate during an Alert condition but the water heater must be serviced by a qualified service technician as soon as possible.

### RESETTING CONTROL SYSTEM LOCK OUTS

To reset the control system from a lock out condition; turn the Enable/Disable switch at the base of the unit to the "Disable" position for approximately 20 seconds and then back to the "Enable" position. Keep in mind: if the condition that caused the Fault has not been corrected, the control system will continue to lock out.

### DIAGNOSTIC CHECKS

**WARNING**

**Electrical Shock Hazard**

- Turn off power to the water heater before performing any service.
- Label all wires prior to disconnecting when performing service. Wiring errors can cause improper and dangerous operation.
- Verify proper operation after servicing.
- Failure to follow these instructions can result in personal injury or death.

The following section, Fault And Alert Messages lists some of the messages the control system will display on the LCD when there

### FAULT AND ALERT MESSAGES

Call the technical support phone number listed on the back cover for further technical assistance or to locate a qualified service technician in your area.

POSSIBLE CAUSES - CHECK/REPAIR	DISPLAYED FAULT/ALERT MESSAGE
<ul style="list-style-type: none"> <li>Using a manometer, ensure that gas supply pressure is above minimum requirement listed on heater's data plate and does not drop more than 1.5" W.C. when unit fires.</li> <li>Ensure wire connections to gas control valve are clean and tight.</li> <li>Ensure wire connections to flame sensor are clean and tight.</li> <li>Ensure wire connections to spark igniter are clean and tight.</li> <li>Inspect flame sensor, clean/replace as needed.</li> <li>Inspect spark igniter, realign igniter gap as needed</li> <li>Ensure adequate electrical ground to heater.</li> </ul>	<div style="border: 1px solid black; padding: 10px; margin-bottom: 10px;"> <p style="font-size: 1.2em; font-weight: bold;">Ignition Failure</p> <p>0 days 0 hrs 0 mins ago Error Code: B2-70</p> <div style="display: flex; align-items: center; justify-content: space-between;"> <div style="text-align: left;"> <p>Flame not detected. Clean flame rod. Check gas supply.</p> <p>Press the Advanced button for more information</p> </div> <div style="text-align: right;"> </div> </div> <div style="display: flex; justify-content: space-around; margin-top: 5px;"> <span>BACK</span> <span>ADVANCED</span> </div> </div> <div style="border: 1px solid black; padding: 10px;"> <p style="font-size: 1.2em; font-weight: bold;">Blocked Exhaust</p> <p>0 days 0 hr 0 min ago Error Code: A8-1201</p> <div style="display: flex; align-items: center; justify-content: space-between;"> <div style="text-align: left;"> <p>Restriction in exhaust pipe. Check exhaust pipe and termination for blockage.</p> <p>Press the Advanced button for</p> </div> <div style="text-align: right;"> </div> </div> <div style="display: flex; justify-content: space-around; margin-top: 5px;"> <span>BACK</span> <span>ADVANCED</span> </div> </div>
<ul style="list-style-type: none"> <li>If Blocked Exhaust error occurs when blower is running, check for restrictions in exhaust pipe, including exhaust elbow, condensate drain, and outside termination. Also check exhaust pipe installation (size/length) per manual.</li> <li>If Blocked Exhaust error occurs before blower runs, make sure pressure switch connections are clean and tight. Check pressure switch continuity/resistance. Switch should be closed (continuity/0 ohms). Replace switch if open (no continuity).</li> <li>High wind conditions may be another possible cause.</li> </ul>	

are operational problems. This is not a complete list. Along with each of the Fault and Alert messages described there will be a list of possible causes and things to check and repair.

Only qualified service technician, as defined in Qualifications using appropriate test equipment, should perform any service procedures on the water heater.

**NOTE:** If you are not qualified and licensed or certified as required by the authority having jurisdiction to perform a given task do not attempt to perform any of the diagnostic or service procedures described in the following section.

If you do not understand the instructions in the following section do not attempt to perform any procedures.

Call the technical support phone number listed on the back cover of this manual for further technical assistance or to locate a qualified service technician in your area.

**WARNING**

**Jumping out control circuits or components can result in property damage, personal injury or death.**







- Service should only be performed by a qualified service technician using proper test equipment.
- Altering the water heater controls and/or wiring in any way could result in permanent damage to the controls or water heater and is not covered under the limited warranty.

Any bypass or alteration of the water heater controls and/or wiring will result in voiding the appliance warranty.

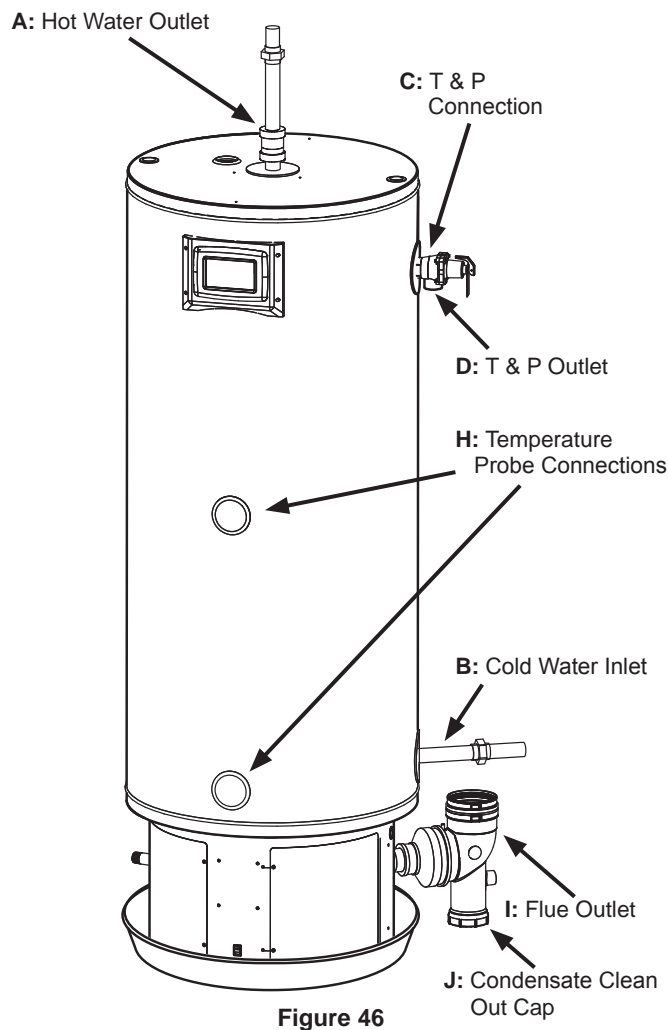


**FAULT AND ALERT MESSAGES (CONT)**

Call the technical support phone number listed on the back cover for further technical assistance or to locate a qualified service technician in your area.

POSSIBLE CAUSES - CHECK/REPAIR	DISPLAYED FAULT/ALERT MESSAGE
<ul style="list-style-type: none"> <li>• If Blocked Intake error occurs before blower runs, make sure pressure switch connections are clean and tight.</li> <li>• If Blocked Intake error occurs when blower is running, check for restrictions in intake pipe, including intake air connection, intake air filter, outside termination, and inlet moisture drains.</li> <li>• Other possible causes: High wind conditions, excessive negative air pressure in building.</li> <li>• Use a multi-meter to check the continuity / resistance of inlet air pressure switch. Switch should be open (no continuity) when the blower is off and closed (shorted) when the blower is on. Replace the switch if necessary.</li> </ul>	<div style="border: 1px solid black; padding: 5px;"> <p style="text-align: center;"><b>Blocked Air Intake</b> 0 days 0 hrs 0 mins ago Error Code: A7-1201</p> <div style="display: flex; justify-content: space-between; align-items: center;"> <div style="text-align: left;">  <p>Restriction in air intake. Check intake pipe and termination for blockage.</p> </div> <div style="text-align: right;">    </div> </div> <p style="text-align: center;">Press the Advanced button for</p> <div style="display: flex; justify-content: space-around; margin-top: 5px;"> <span>BACK</span> <span>ADVANCED</span> </div> </div>
<ul style="list-style-type: none"> <li>• Ensure wire connections to upper temperature probe are clean and tight.</li> <li>• Using a thermometer, check the water temperature of the heater.</li> <li>• Use a multi-meter and check for continuity between the two red wires of the upper temperature probe.</li> <li>• If the two red wires are open (no continuity) and water temperature is below 160°F, replace upper temperature probe.</li> <li>• If the water temperature exceeds 195°F, turn off electric power and gas supply and call Tech Support for further instructions.</li> </ul>	<div style="border: 1px solid black; padding: 5px;"> <p style="text-align: center;"><b>High Temp Limit Exceeded</b> 0 days 0 hrs 0 mins ago Error Code: A5-401</p> <div style="display: flex; justify-content: space-between; align-items: center;"> <div style="text-align: left;">  <p>Energy Cut Off has shut off water heater due to high tank temperature.</p> </div> <div style="text-align: right;">    </div> </div> <p style="text-align: center;">Press the Advanced button for</p> <div style="display: flex; justify-content: space-around; margin-top: 5px;"> <span>BACK</span> <span>ADVANCED</span> </div> </div>

# LEAKAGE CHECKPOINTS




Never use this water heater unless it is completely filled with water. To prevent damage to the tank, the tank must be filled with water. Water must flow from the hot water faucet before turning "ON" gas to the water heater.

- A \*Condensation may be seen on the hot water outlet pipe in humid weather or the hot water outlet connection may be leaking.
- B. \*Condensation may be seen on the cold water inlet pipe in humid weather or the cold water inlet connection may be leaking.
- C. Small amounts of water from temperature-pressure relief valve may be due to thermal expansion or high water pressure in your area.
- D. \*The temperature-pressure relief valve may be leaking at the tank fitting.
- E. Water from a drain valve may be due to the valve being slightly opened. (Not shown in Figure 46).
- F. \*The drain valve may be leaking at the tank fitting. (Not shown in Figure 46).
- G. Leakage from recirculation plug or pipe connection. (Not shown in Figure 46).
- H. Leakage from the temperature probe connections.
- I. Condensate from the exhaust connection.
- J. Condensate Clean Out Cap

Leakage from other water heaters, water lines, or ground seepage should also be checked.

\* To check where threaded portion enters tank, insert cotton swab between jacket opening and fitting. If cotton is wet, follow the "Draining" instructions in Draining and Flushing on Page 55 and then remove the fitting. Put pipe dope or teflon tape on the threads and replace. Then follow the instructions in Filling the Water Heater on Page 44..



**⚠ WARNING**

Read and understand instruction manual and safety messages before installing, operating or servicing this water heater.

Failure to follow instructions and safety messages could result in death or serious injury.

Instruction Manual must remain with water heater.


## PERIODIC MAINTENANCE

Should overheating occur or the gas supply fails to shut off, turn off the manual gas control valve to the appliance.

### VENTING SYSTEM INSPECTION

**! WARNING**

**Breathing Hazard - Carbon Monoxide Gas**



- Flue gases may escape if vent pipe is not connected.
- Be alert for obstructed, sooted or deteriorated vent system to avoid serious injury or death.
- Do not store corrosive chemicals in vicinity of water heater.
- Chemical corrosion of flue and vent system can cause serious injury or death.
- Analyze the entire vent system to make sure that condensate will not become trapped in a section of vent pipe and therefore reduce the open cross sectional area of the vent.

Breathing carbon monoxide can cause brain damage or death. Always read and understand instruction manual.

At least once a year examine the vent system. Points of inspection are as follows:

1. Check for obstructions and/or deterioration of the intake air and/or vent piping and the intake air and vent terminations. Replace immediately where needed.

**NOTE:** Do not reach inside the vent termination when the heater is in operation.

2. Check all vent system connections for leakage and repair or reseal as necessary.

Be sure the vent piping is properly connected to prevent escape of dangerous flue gasses which could cause deadly asphyxiation.

Obstructions and deteriorated vent systems may present serious health risk or asphyxiation.

Chemical vapor corrosion of the flue and vent system may occur if air for combustion contains certain chemical vapors. Spray can propellants, cleaning solvents, refrigerator and air conditioner refrigerants, swimming pool chemicals, calcium and sodium chloride, waxes, bleach and process chemicals are typical compounds which are potentially corrosive.

If after inspection of the vent system you found sooting or deterioration, something is wrong. Call the local gas utility to correct the problem and clean or replace the flue and venting before resuming operation of the water heater.

### INTEGRATED FILTER PREVENTATIVE MAINTENANCE

The heater is designed to shut down if the pressure switch senses that the air inlet vent or the exhaust vent is restricted. In this case, the pressure switch will open and the heater will generate the "Blocked Air Intake" fault (see Fault and Alert Messages beginning on Page 51). If the troubleshooting section of this manual indicates that there is a blockage at the air inlet integrated filter, note the following:

- Turn off the gas supply to the water heater at the manual gas shut-off valve (see Figure 37 on Page 31), and disconnect power to the water heater. See Electrical Wiring on Page 33.
- To inspect the filter, loosen the hose clamp at the adaptor rubber boot and slide the plastic pipe out and away from the adaptor rubber boot (See Figure 14 in Integrated Filter Installation).
- Remove the adaptor rubber boot containing the outer clamshell housing by turning clockwise approximately 1/2" (30.5 cm) and pulling off of the internal clamshell housing (See Figure 14 in Integrated Filter Installation).
- Using your fingers or a small flat blade screwdriver, remove the filter media from the outer clamshell housing, handle carefully

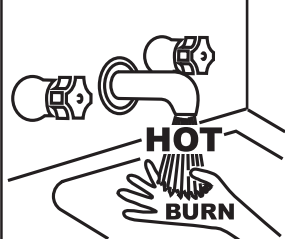
(See Figure 16 in Integrated Filter Installation).

- To clean filter, lightly tap the back of the filter support to dislodge any large debris. Smaller debris may be
- Removed by using a vacuum cleaner. The filter media may be cleaned by dipping the filter media into a
- Solution of warm soapy water and rinsing in clean water. Do not scrub, allow to air dry before reinstalling.
- Filter media may be cleaned on an average 2 to 3 times before replacing with a new filter media is required.
- Reinstall filter media by doing the above steps in reverse order.
- Turn on the gas supply and reconnect power. Refer to Electrical Wiring on Page 33, Control System Operation on Page 36, and Start Up on Page 44. Verify proper operation of the water heater before leaving.

The water heater must never be operated without the filter media installed. Damages or service calls associated with operating the heater without the filter media installed are not covered under the limited warranty.

### TEMPERATURE-PRESSURE RELIEF VALVE TEST

**! DANGER**



- Burn hazard.
- Hot water discharge.
- Keep clear of Temperature-Pressure Relief Valve discharge outlet.

It is recommended that the Temperature-Pressure Relief Valve should be checked to ensure that it is in operating condition every 6 months.

When checking the Temperature-Pressure Relief Valve operation, make sure that (1) no one is in front of or around the outlet of the Temperature-Pressure Relief Valve discharge line, and (2) that the water discharge will not cause any property damage, as the water may be extremely hot. Use care when operating valve as the valve may be hot.

To check the temperature-pressure relief valve, lift the lever at the end of the valve several times. Refer to Figure 47 below. The valve should seat properly and operate freely.

If after manually operating the valve, it fails to completely reset and continues to release water, immediately close the cold water inlet to the water heater and drain the water heater, see Draining and Flushing on Page 55. Replace the Temperature-Pressure Relief Valve with a properly rated/sized new one, see Temperature-Pressure Relief Valve on Page 20 for instructions on replacement.

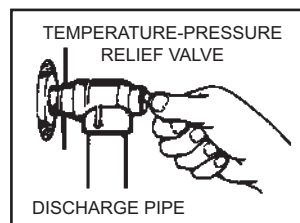


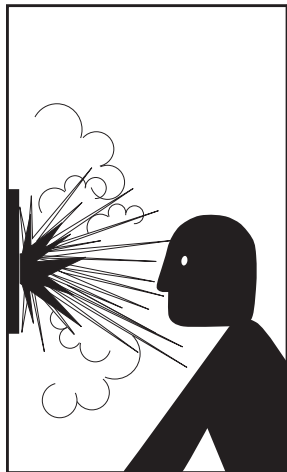
Figure 47

If the Temperature-Pressure Relief Valve on the water heater weeps or discharges periodically, this may be due to thermal expansion.

**NOTE:** Excessive water pressure is the most common cause of Temperature-Pressure Relief Valve leakage. Excessive water system pressure is most often caused by “thermal expansion” in a “closed system.” See Closed Water Systems and Thermal Expansion on Page 19. The Temperature-Pressure Relief Valve is not intended for the constant relief of thermal expansion.

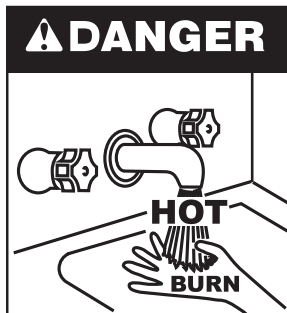
Temperature-Pressure Relief Valve leakage due to pressure build up in a closed system that does not have a thermal expansion tank installed is not covered under the limited warranty. Thermal expansion tanks must be installed on all closed water systems.

**DO NOT PLUG THE TEMPERATURE-PRESSURE RELIEF VALVE OPENING. THIS CAN CAUSE PROPERTY DAMAGE, SERIOUS INJURY OR DEATH.**

	<h2>⚠ WARNING</h2> <h3>Explosion Hazard</h3>
	<ul style="list-style-type: none"> <li>• Temperature-Pressure Relief Valve must comply with ANSI Z21.22- CSA 4.4 and ASME code.</li> <li>• Properly sized temperature-pressure relief valve must be installed in opening provided.</li> <li>• Can result in overheating and excessive tank pressure.</li> <li>• Can cause serious injury or death.</li> </ul>

## DRAINING AND FLUSHING

It is recommended that the water heater storage tank be drained and flushed every 6 months to reduce sediment buildup. The water heater should be drained if being shut down during freezing temperatures. See Figures 2 & 3 in Features and Components for the location of the water heater components described below.

	<h2>⚠ DANGER</h2>
	<ul style="list-style-type: none"> <li>• Burn hazard.</li> <li>• Hot water discharge.</li> <li>• Keep hands clear of drain valve discharge.</li> </ul>

### TO DRAIN THE WATER HEATER STORAGE TANK:

1. Switch the Enable/Disable switch, located at the base of the water heater, to the “Disable” position and then turn off the electrical supply to the water heater.

2. Turn off the gas supply at the Main Gas Shutoff Valve (see Figure 37 on Page 31) if the water heater is going to be shut down for an extended period.
3. Ensure the cold water inlet valve is open.
4. Open a nearby hot water faucet and let the water run until the water is no longer hot.
5. Close the cold water inlet valve to the water heater.
6. Connect a hose to the water heater drain valve and terminate it to an adequate drain.
7. Open the water heater drain valve and allow all the water to drain from the storage tank.
8. Close the water heater drain valve when all water in the storage tank has drained.
9. Close the hot water faucet opened in Step 4.
10. If the water heater is going to be shut down for an extended period, the drain valve should be left open.

### TO FLUSH THE WATER HEATER STORAGE TANK:

1. Switch the Enable/Disable switch, located at the base of the water heater, to the “Disable” position and then turn off the electrical supply to the water heater.
2. Ensure the cold water inlet valve is open.
3. Open a nearby hot water faucet and let the water run until the water is no longer hot. Then close the hot water faucet.
4. Connect a hose to the drain valve and terminate it to an adequate drain.
5. Ensure the drain hose is secured before and during the entire flushing procedure. Flushing is performed with system water pressure applied to the water heater.
6. Open the water heater drain valve to flush the storage tank.
7. Flush the water heater storage tank to remove sediment and allow the water to flow until it runs clean.
8. Close the water heater drain valve when flushing is completed.
9. Remove the drain hose.
10. Fill the water heater - see Filling The Water Heater on page 44.
11. Turn on the electrical supply to place the water heater back in operation and switch the Enable/Disable switch to the “Enable” position.
12. Allow the water heater to complete several heating cycles to ensure it is operating properly.

## SERVICE

If a condition persists or you are uncertain about the operation of the water heater contact a qualified service technician.

Use this guide to check a leaking water heater. Many suspected Leakers are not leaking tanks. Often the source of the water can be found and corrected.

If you are not thoroughly familiar with gas codes, your water heater, and safety practices, contact your gas supplier or qualified installer to check the water heater.

Read this manual first. Then before checking the water heater make sure the gas supply has been turned “OFF”, and never turn the gas “ON” before the tank is completely full of water.

# DIAGRAMS

## CCB - CENTRAL CONTROL BOARD LAYOUT

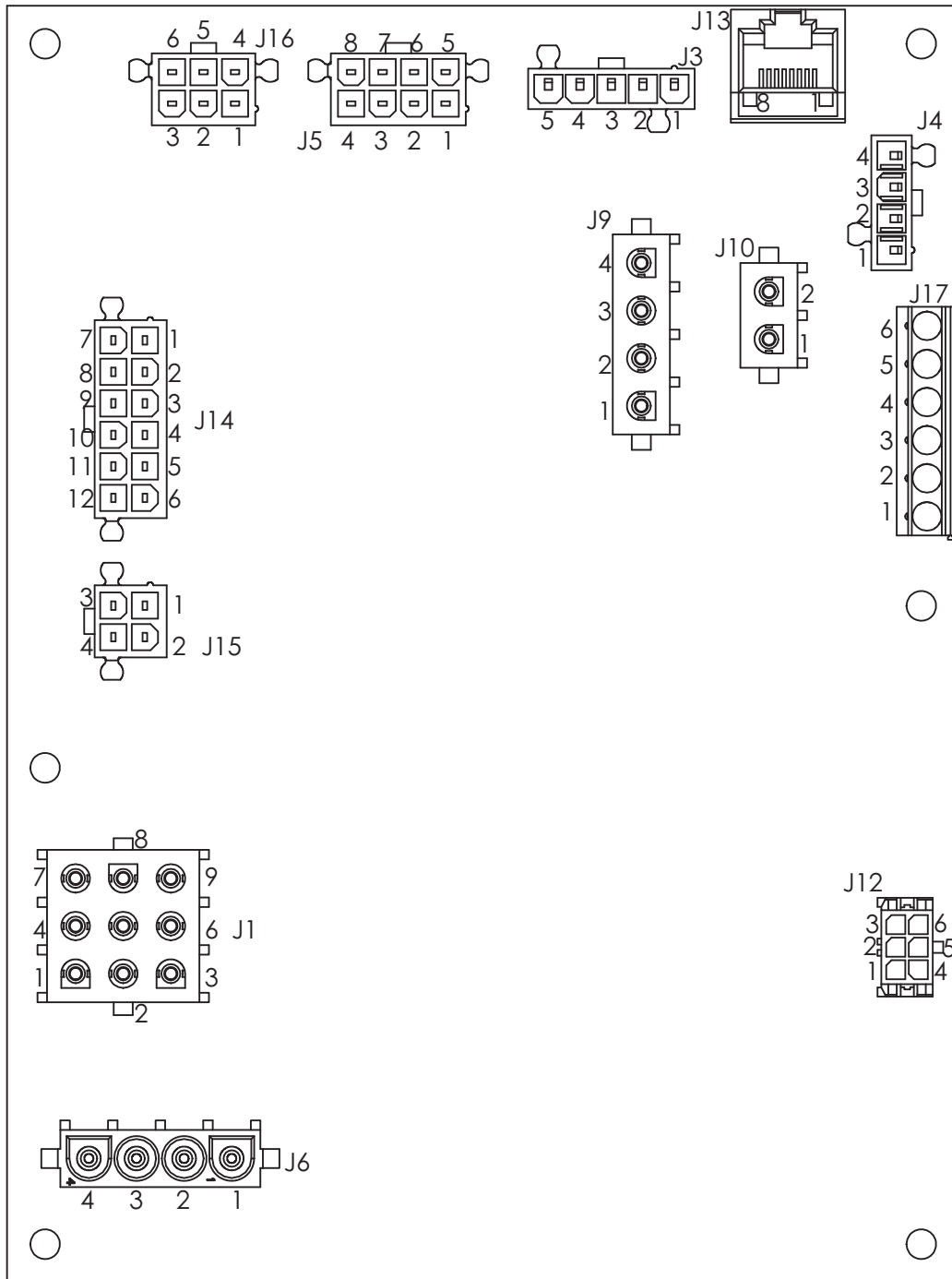


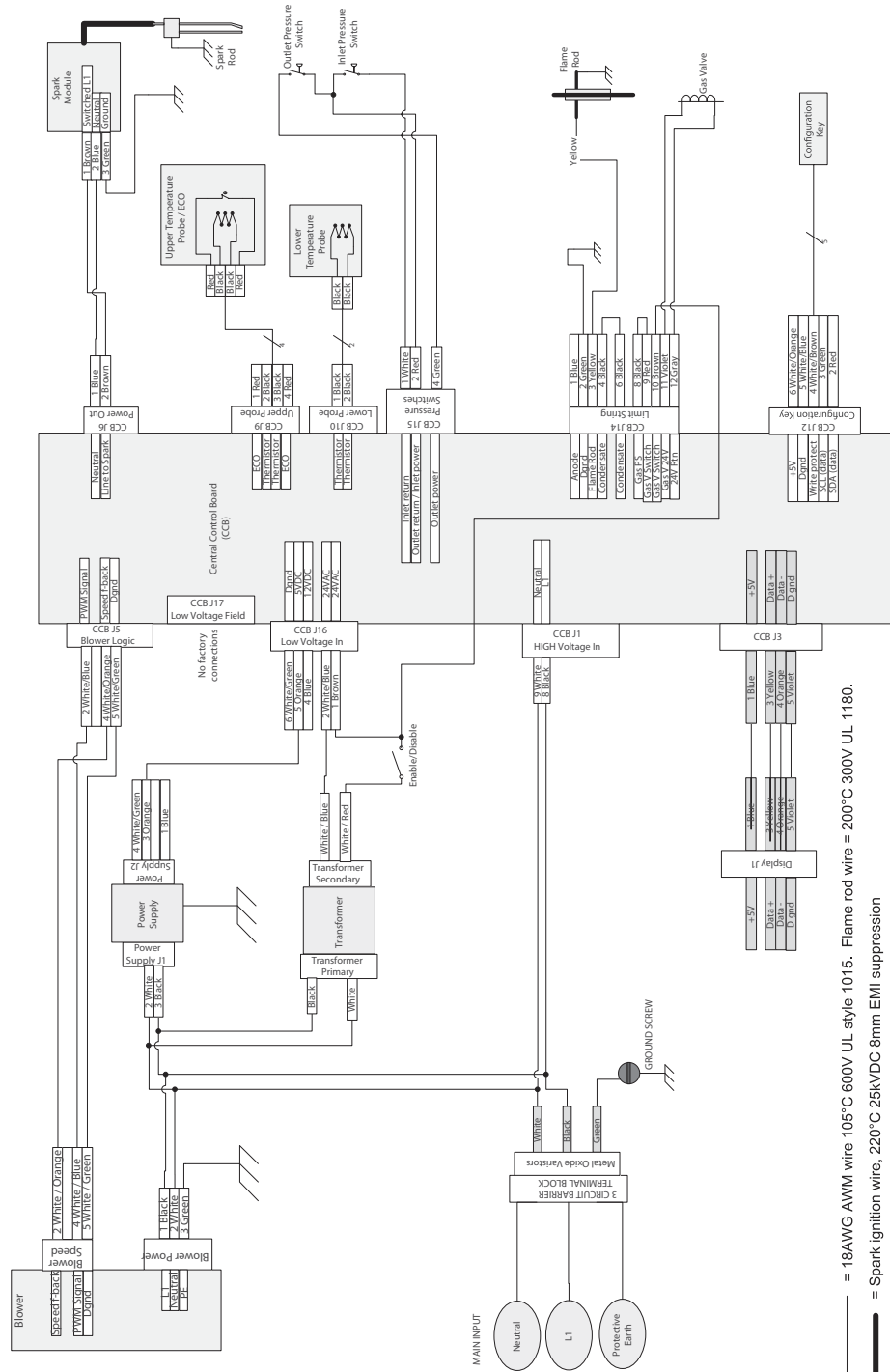
Figure 48



# WIRING DIAGRAM



**CAUTION**  
 LABEL ALL WIRES PRIOR TO DISCONNECTION WHEN SERVICING CONTROLS. WIRING ERRORS CAN CAUSE IMPROPER AND DANGEROUS OPERATION. VERIFY PROPER OPERATION AFTER SERVICING.



— = 18AWG AWM wire 105°C 600V UL style 1015. Flame rod wire = 200°C 300V UL 1180.  
 — = Spark ignition wire, 220°C 25kVDC 8mm EMI suppression

**WARNING**

DISCONNECT FROM ELECTRICAL SUPPLY BEFORE SERVICING UNIT.  
 REPLACE ALL DOORS AND PANELS BEFORE OPERATING HEATER.

IF ANY OF THE ORIGINAL WIRES SUPPLIED WITH THE APPLIANCE MUST BE REPLACED, IT MUST BE REPLACED WITH APPLIANCE WIRE MATERIAL WITH MINIMUM TEMPERATURE RATING OF 105°C AND A MINIMUM SIZE OF NO. 18 AWG.

**Figure 49: WIRING SCHEMATIC (All Models)**

CIRCULATING PUMP WIRING DIAGRAM  
STORAGE TANK OR BUILDING RECIRCULATION

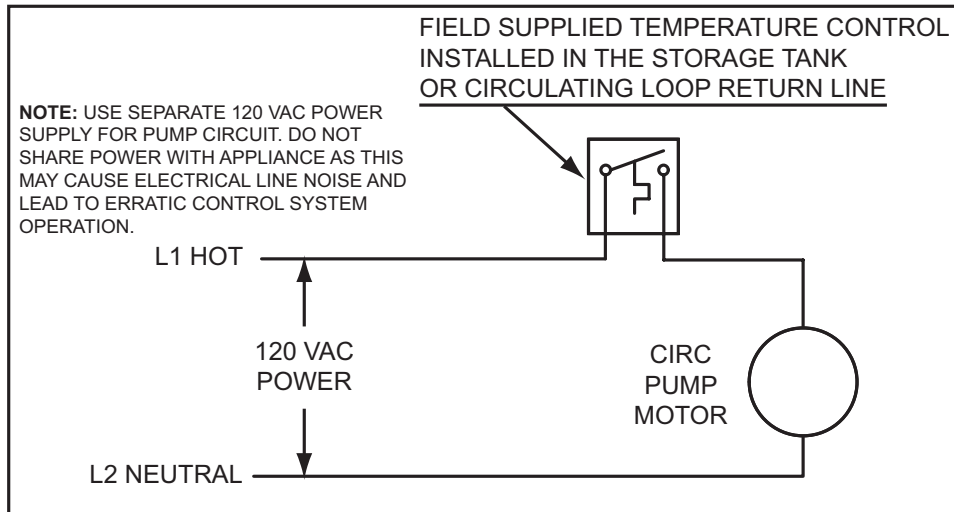


Figure 50

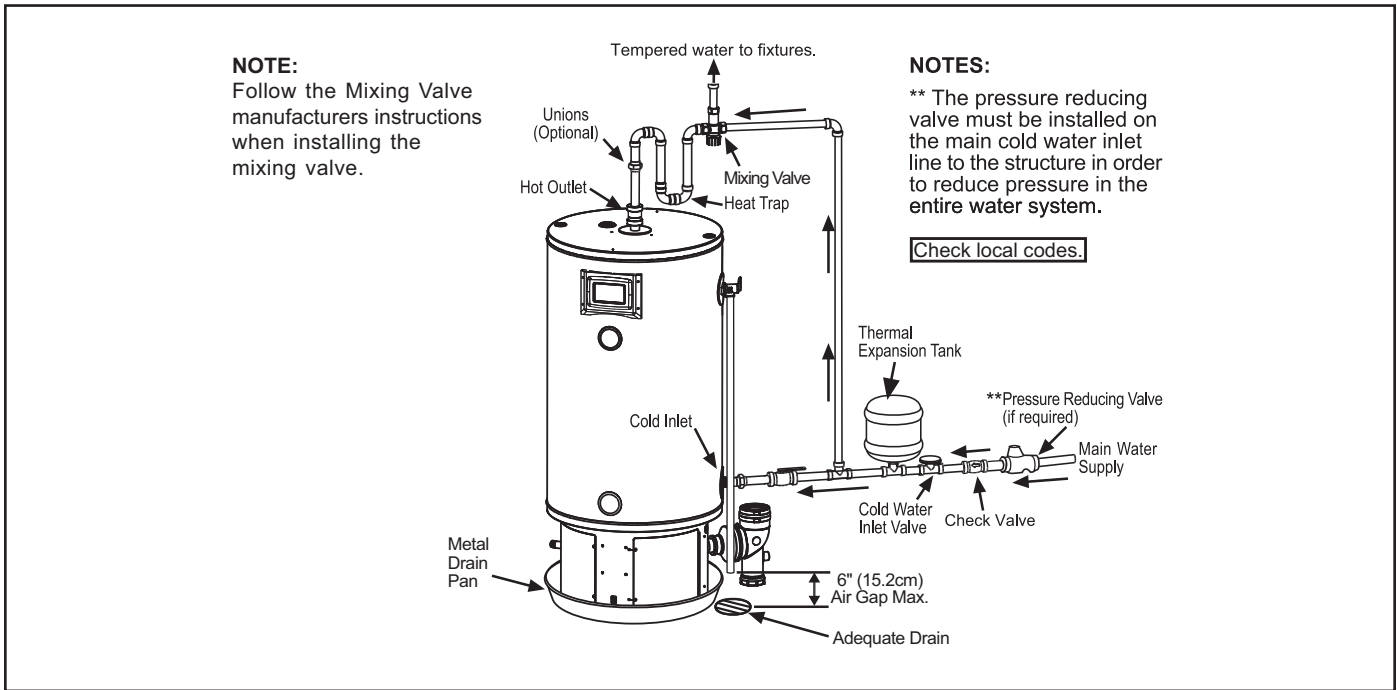


Figure 51: TYPICAL ONE-TEMPERATURE SYSTEM PIPING INSTALLATION (All Models)

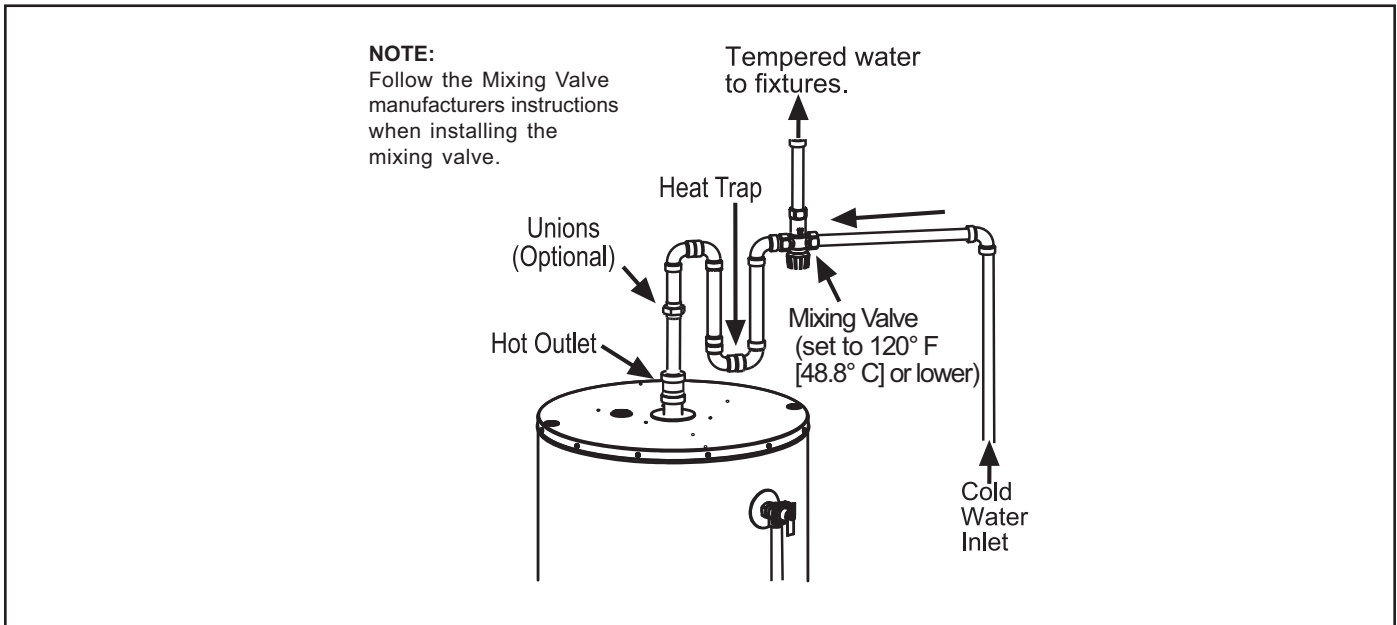
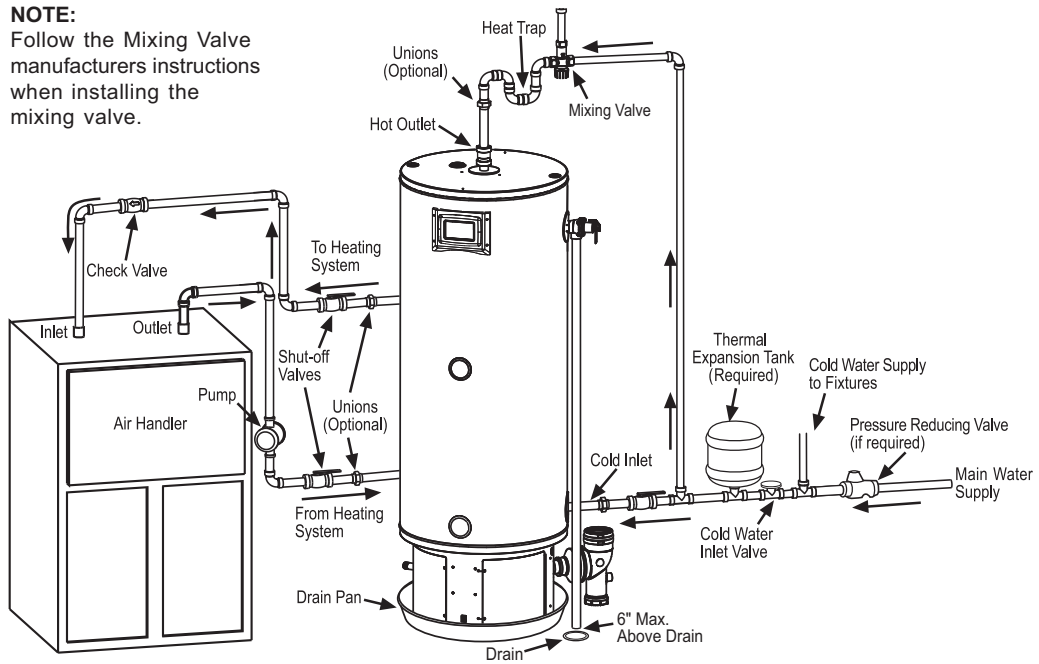


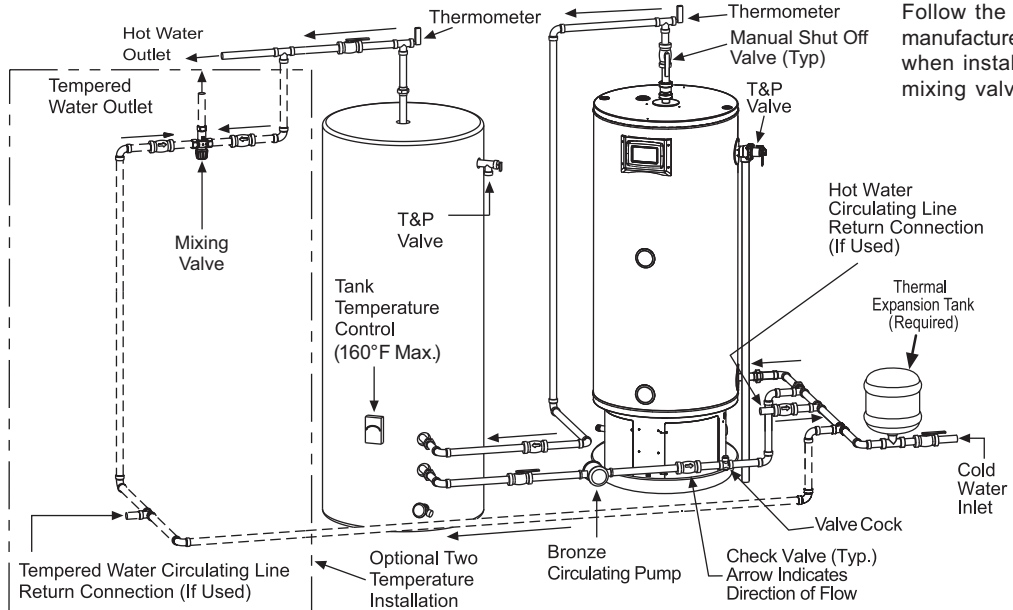
Figure 52: SAMPLE MIXING VALVE INSTALLATION (All Models)

**NOTE:**  
Follow the Mixing Valve manufacturers instructions when installing the mixing valve.



**Figure 53: AIR HANDLER PIPING INSTALLATION (All Models)**

**NOTE:**  
Follow the Mixing Valve manufacturers instructions when installing the mixing valve.



**Figure 54: POLARIS WITH AUXILLARY STORAGE TANK,  
One or Two Temperature System (With or Without Building Recirculation)**

## NOTES



## NOTES

# **POLARIS®**

For Tech Support please call  
PR models:  
1-888-479-8324  
599 Hill Street West  
Fergus, ON Canada, N1M2X1