

Installation Instructions and Use & Care Guide



Hybrid Electric Heat Pump Water Heater

DO NOT RETURN THIS UNIT TO THE STORE



Read this manual and the labels on the water heater before you install, operate, or service it. If you have difficulty following the directions, or aren't sure you can safely and properly do any of this work yourself:

- Call our Technical Assistance Hotline at **1-888-479-8324**. We can help you with installation, operations, troubleshooting, or maintenance. Before you call, write down the model and serial number from the water heater's data plate.

Incorrect installation, operation, or service can damage the water heater, your house and other property, and present risks including fire, scalding, electric shock, and explosion, causing serious injury or death.

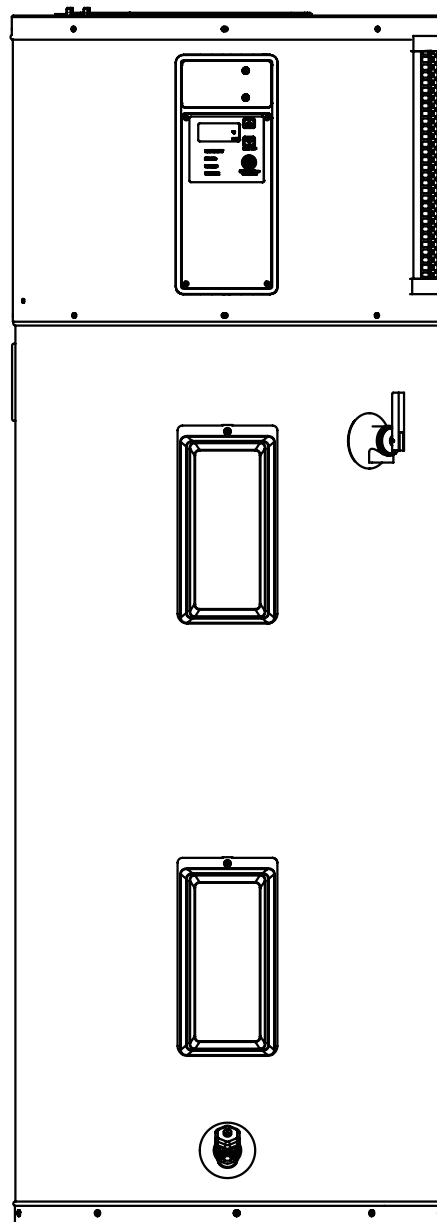

| Table of Contents | Page |
|------------------------------------|------|
| IMPORTANT SAFETY INFORMATION | 3 |
| GETTING STARTED | 6 |
| INSTALLATION | 7 |
| DIAGNOSTIC CODES..... | 20 |
| TROUBLESHOOTING CHART | 22 |
| MAINTENANCE | 28 |
| REPAIR PARTS ILLUSTRATION | 33 |

Keep this manual in the pocket on heater for future reference whenever maintenance, adjustment or service is required.

Retain your original receipt as proof of purchase.

COMPLETED INSTALLATION (TYPICAL)

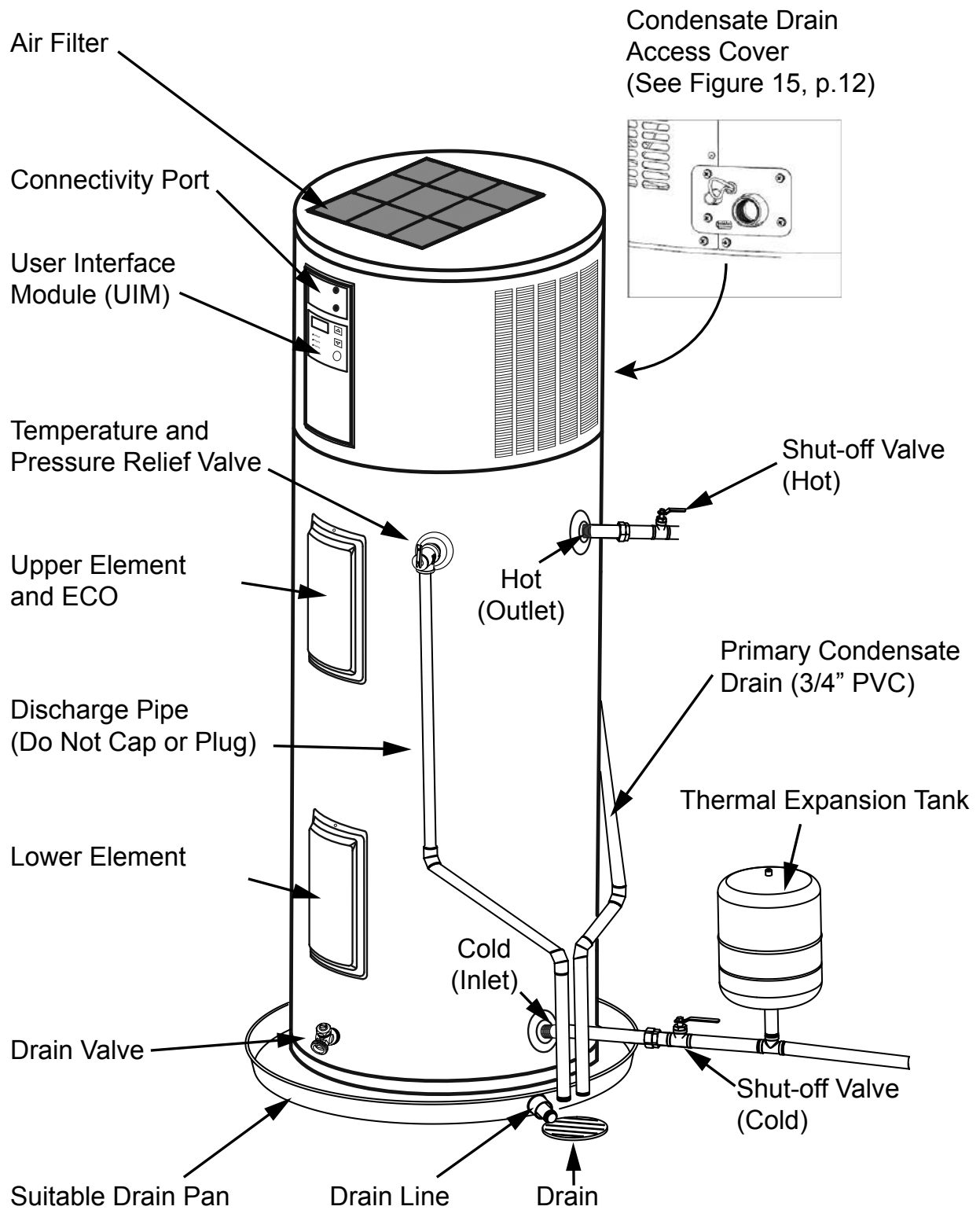

IMPORTANT SAFETY INFORMATION

Read and follow all safety messages and instructions in this manual.

| | |
|---|---|
|  | <p>This is the safety alert symbol. It is used to alert you to potential physical injury hazards. Obey all safety messages that follow this symbol to avoid possible property damage, serious injury or death. Do not remove any permanent instructions, labels, or the data plate from either the outside of the water heater or on the inside of the access panels. Keep this manual near the water heater.</p> |
|---|---|

Important information to keep

Fill out this section and keep this manual in the pocket of the water heater for reference.



Date Purchased:

Model number:

Serial number:

| Maintenance performed:* | Date: |
|-------------------------|-------|
| _____ | _____ |
| _____ | _____ |
| _____ | _____ |
| _____ | _____ |
| _____ | _____ |
| _____ | _____ |
| _____ | _____ |
| _____ | _____ |
| _____ | _____ |

*Drain and flush tank, clean air filter, clean condensate pan, and remove and inspect anode rod after first six months of operation and at least annually thereafter. Operate the Temperature and Pressure Relief Valve (T&P) annually and inspect T&P valve every 2-4 years (see the label on the T&P valve for maintenance schedule). See the Maintenance section for more information about maintaining this water heater.

| | |
|--|--|
|  DANGER | DANGER indicates hazardous situation that, if not avoided, will result in death or serious injury. |
|  WARNING | WARNING indicates a hazardous situation that, if not avoided, could result in death or serious injury. |
|  CAUTION | CAUTION indicates a hazardous situation that, if not avoided, could result in minor or moderate injury. |
| NOTICE | NOTICE indicates practices not related to physical injury. |

IMPORTANT SAFETY INFORMATION

To reduce the risk of property damage, serious injury or death, read and follow the precautions below, all labels on the water heater, and the safety messages and instructions throughout this manual.

RISKS DURING INSTALLATION AND MAINTENANCE



Electric Shock Risk

Contact with the electrical parts in the junction box, behind the access doors and inside the top shroud can result in severe injury or death from electrical shock:

- Disconnect power by opening the circuit breaker or removing the fuses before installing or servicing.
- Use a non-contact circuit tester to confirm that power is off before working on or near any electrical parts.
- Replace the junction box cover and access doors after servicing.



Lifting Risk

The water heater is heavy. Follow these precautions to reduce the risk of property damage, injuries from lifting or impact injuries from dropping the water heater.

- Use at least two people to lift the water heater.
- Be sure you both have a good grip before lifting.
- Unit is top heavy, use an appliance dolly (with strap) to move the water heater.

RISKS DURING OPERATION

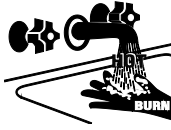

Scalding Risk

This water heater can make water hot enough to cause severe burns instantly, resulting in severe injury or death.

- Feel water before bathing or showering
- To reduce the risk of scalding, install Thermostatic Mixing Valves (temperature limiting valves) at each point-of-use. These valves automatically mix hot and cold water to limit the temperature at the tap. Mixing valves are available from your local plumbing supplier. Follow manufacturer's instructions for installation and adjustment of the valves.
- The User Interface Module (UIM) on this water heater have been factory set to approximately 140°F/60°C. Higher temperatures increase the risk of scalding. Refer to the National Plumbing Code for requirements limiting the allowable temperatures at fixtures in the home. Thermostatic Mixing Valves are particularly important to help avoid scalding.

| Temperature | Time to Produce a Serious Burn |
|--------------|--------------------------------|
| 120°F (49°C) | More than 5 minutes |
| 125°F (52°C) | 1½ to 2 minutes |
| 130°F (54°C) | About 30 seconds |
| 135°F (57°C) | About 10 seconds |
| 140°F (60°C) | Less than 5 seconds |
| 145°F (63°C) | Less than 3 seconds |
| 150°F (66°C) | About 1½ seconds |
| 155°F (68°C) | About 1 second |

For information about changing the factory thermostat setting(s), refer to the "Adjusting the Temperature" section in this manual ("Step 12:").

Regardless of the water heater thermostat(s) setting, higher temperatures may occur in certain circumstances:

- In some cases, repeated small draws of water can cause the hot and cold water in the tank to "stack" in layers. If this happens, the water can be as much as 30F°/15C° hotter than the thermostat setting. This temperature variation is the result of your usage pattern and is not a malfunction.
- Water temperature will be hotter if someone adjusted the thermostat(s) to a higher setting.
- Problems with the thermostat(s), or other malfunctions may result in higher than expected water temperatures.
- If the water heater is in a hot environment, the water in the tank can become as hot as the surrounding air, regardless of the thermostat setting.
- If the water supplied to the water heater is pre-heated (for example, by a solar system) the temperature in the tank may be higher than the water heater's thermostat setting.

To reduce the risk of unusually hot water reaching the fixtures in the house, install Thermostatic Mixing Valves.

If anyone in your home is at particular risk of scalding (for example, the elderly, children, or people with disabilities) or if there is a local code or state law requiring a certain water temperature at the hot water tap, then these precautions are particularly important.

IMPORTANT SAFETY INFORMATION

According to a national standard American Society of Sanitary Engineering (ASSE 1070) and most local plumbing codes, the water heater's thermostat should not be used as the sole means to regulate water temperature and avoid scalds.

Properly adjusted Thermostatic Mixing Valves allow you to set the tank temperature to a higher setting without increasing risk of scalds. A higher temperature setting allows the tank to provide much more hot water and can help provide proper water temperatures for appliances such as dishwashers and washing machines. Higher tank temperatures (140°F/60°C) also kill bacteria that cause a condition known as "smelly water" and can reduce the levels of bacteria that cause water-borne diseases.

Water Contamination Risk

Do not use chemicals that could contaminate the potable water supply. Do not use piping that has been treated with chromates, boiler seal, or other chemicals.



Fire Risk

To reduce the risk of a fire that could destroy your home and seriously injure or kill people:

- Do not store things that can burn easily such as paper or clothes next to the water heater.
- Be sure the junction box cover and the access door covers are in place. These covers keep debris from entering and potentially being ignited, and help keep any internal fires from spreading.

- Keep the water heater from becoming wet. Immediately shut the water heater off and have it inspected by a qualified person if you find that the wiring, thermostat(s) or surrounding insulation have been exposed to water in any way (e.g., leaks from plumbing, leaks from the water heater itself can damage property and could cause a fire risk). If the water heater is subjected to flood conditions or the thermostat(s) have been submerged in water, the entire water heater must be replaced.
- Make electrical connections properly, according to the instructions on page 15. Use 10 gauge solid copper wire. Use a UL listed or CSA approved strain relief. Connect ground wire to green ground screw.



Explosion Risk

High temperatures and pressures in the water heater tank can cause an

explosion resulting in property damage, serious injury or death. A new Temperature and Pressure (T&P) Relief Valve is included with your water heater to reduce risk of explosion by discharging hot water. Additional temperature and pressure protective equipment may be required by local codes.

A nationally recognized testing laboratory maintains periodic inspection of the valve production process and certifies that it meets the requirements for Relief Valves for Hot Water Supply Systems, ANSI Z21.22. The T&P Relief Valve's relief pressure must not exceed the working pressure rating of the water heater as stated on the rating plate.

Maintain the T&P Relief Valve properly. Follow the maintenance instructions provided by the manufacturer of the T&P Relief Valve (label attached to T&P Relief Valve) and the procedure on page 31.

An explosion could occur if the T&P Relief Valve or discharge pipe is blocked. Do not cap or plug the T&P Relief Valve or discharge pipe.

Fire and Explosion Risk if Hot Water is Not Used for Two Weeks or More

⚠ CAUTION! Hydrogen gas builds up in a hot water system when it is not used for a long period (two weeks or more). Hydrogen gas is extremely flammable. If the hot water system has not been used for two weeks or more, open a hot water faucet for several minutes at the kitchen sink before using any electrical appliances connected to the hot water system. Do not smoke or have an open flame or other ignition source near the faucet while it is open.

GETTING STARTED

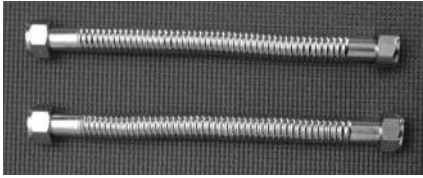

Figure 1 - Flexible connectors use compression fittings and do not require soldering.



Figure 2 - Use a non-contact circuit tester to insure that the power is off before you work on a circuit.



Figure 3 - Install a Pressure Reducing Valve if required.



Figure 4 - Condensate overflow flexible tubing.

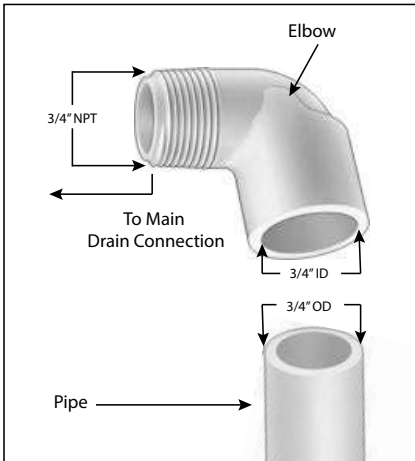

Figure 5 - Main Drain Connection piping.

1 Review all of the instructions before you begin work.

Improper installation can damage the water heater, your home and other property, and can present risks of serious injury or death.

2 Check with your local and provincial authorities for any local or provincial codes that apply to your area. In the absence of local and provincial codes, follow the current editions of the Canadian Electric Code (CEC) and the National Plumbing Code (NPC). The instructions in this manual comply with national codes, but the installer is responsible for complying with local codes.

3 Before you start, be sure you have, and know how to use, the following tools and supplies:

- Plumbing tools and supplies appropriate for the type of water pipes in your home
- Threaded connectors (Figure 1) for the cold and hot water pipes
- For homes plumbed with plastic pipe, use threaded connectors suitable for the specific type of plastic pipe used: CPVC and PEX (cross-linked polyethylene). Do not use PVC pipe.
- For homes with copper pipes, you may purchase connector kits with compression fittings that don't require soldering (Figure 1). Compression fittings are easier to install than soldering copper pipes.

- Teflon® tape or pipe joint compound approved for potable water
- Tools to make the electrical connections (for example, screwdrivers, wire strippers)
- Non-Contact circuit tester to check for power (Figure 2)
- Water Pressure Gauge (Figure 6)

Recommended Accessories:

- Suitable drain pan (Figure 8)
- Automatic leak detection and shut-off device
- Pressure Reducing Valve (Figure 3)
- Thermal Expansion Tank (Figure 7)
- Thermostatic Mixing Valves (Figure 9)
- 1/2" Flexible tubing for Condensate Overflow (Figure 4)
- 90° Elbow with 3/4" Female Unthreaded Socket End X 3/4" Male NPT Threaded End (Figure 5)
- 3/4" OD Plastic Pipe for Condensate Drain (Figure 5)

INSTALLATION

Follow these steps for proper installation:

Step 1:

✓ Verify that your home is equipped and up-to-date for proper operation

Installing a new water heater is the perfect time to examine your home's plumbing system and make sure the system is up to current code standards. There have likely been plumbing code changes since the old water heater was installed. We suggest installing the following accessories and any other needed changes to bring your home up to the latest code requirements.

Use this checklist and inspect your home. Install any devices you need to comply with codes and assure that your new water heater performs at its best. Check with your local plumbing official for more information.

✓ Water pressure

We recommend checking your home's water pressure with a pressure gauge (Figure 6). Most codes allow a maximum incoming water pressure of 80 psi/550kPa.

HOW: Purchase an inexpensive water pressure gauge available at your local plumbing supplier. Connect the Water Pressure Gauge to an outside faucet and measure the maximum water pressure experienced throughout the day (highest water pressures often occur at night).



Figure 6 - Use a Water Pressure Gauge to make sure your home's water pressure is not too high.

Pressure Reducing Valves are available at your local plumbing supplier.

✓ Water pressure increase caused by thermal expansion

Verify that you have a properly sized Thermal Expansion Tank (Figure 7). We recommend installing an expansion tank if your home does not have one. Codes require a properly pressurized, properly sized Thermal Expansion Tank in homes that have backflow, check, or pressure-reducing valves. (See illustration on inside front cover.)



Figure 7 - A Thermal Expansion Tank helps protect the home's plumbing system from pressure spikes.

HOW: Connect the Thermal Expansion Tank (available at your local plumbing supplier) to the cold water supply line near the water heater. The expansion tank contains a bladder and an air charge. To work properly, the Thermal Expansion Tank must be sized according to the water heater's tank capacity and pressurized to match the home's incoming water pressure. Refer to the installation instructions provided with the Thermal Expansion Tank for installation details.

INSTALLATION

BACKGROUND: Water expands when heated, and the increased volume of water must have a place to go, or thermal expansion will cause large increases in water pressure (despite the use of a Pressure Reducing Valve on the home's main water supply line). Backflow preventers are often installed in water meters and may not be readily visible. As a result, most all plumbing systems today are now "closed," and many homes now need a Thermal Expansion Tank.

A Thermal Expansion Tank is a practical and inexpensive way to help avoid damage to the water heater, washing machine, dishwasher, ice maker and even toilet valves. If your toilet occasionally runs for no apparent reason (usually briefly at night), that may be due to thermal expansion increasing the water pressure temporarily.

✓ Water pipe and tank leaks

Leaks from plumbing pipes or from the water heater itself can damage property and could cause a fire risk.

- Install an automatic leak detection and shutoff device (available at your local plumbing supplier). These devices can detect water leaks and can shut off the water heater's water supply if a leak occurs.



Figure 8 - A suitable drain pan piped to an adequate drain can help protect flooring from leaks and drips.

- If damage could occur as a result of a leak from the water heater or plumbing, install the water heater in a drain pan (available at your local plumbing supplier) (Figure 8) that is piped to an adequate drain. The drain pan must be at least 2"/50mm wider than the diameter of the water heater. Install the drain pan so the water level would be limited to a maximum depth of 1-3/4" (45mm).

✓ Water temperature regulation



Figure 9 - Thermostatic Mixing Valves can help prevent scalds.

Install Thermostatic Mixing Valves if it is necessary (Figure 9) to regulate the temperature of the water. Consult the valve manufacturer's instructions or a qualified person.

⚠ WARNING! Even if the water heater thermostat is set to a relatively low temperature, hot water can scald. **Install Thermostatic Mixing Valves to reduce the risk of scalding (page 4).**

BACKGROUND: A Thermostatic Mixing Valve mixes hot water from the water heater with cold water to more precisely regulate the temperature of hot water supplied to fixtures. If you aren't sure if your plumbing system is equipped with properly installed and adjusted Thermostatic Mixing Valves, contact a qualified person for more information.

Step 2:

Verify that the location is appropriate

Before installing your water heater, ensure that:

- 1 The water heater will be:
 - Installed indoors close to the center of the plumbing system.
 - In a suitable drain pan (if required) piped to an adequate drain (Figure 8).
 - In an area that will not freeze
 - In an area that is suitable for installing the water heater vertically and on a level surface.
 - Installed where a typical home appliance sound would not cause a disturbance
 - Not used for space heating.

NOTICE: Water heater must be level!

INSTALLATION

2 The location has adequate space (clearances) for periodic servicing. For optimal water heater efficiency, the unit must have unrestricted airflow and requires a minimum installation space of 700ft³ (19.8m³). As an example, a room that has an 8 foot tall ceiling and is 10ft (3m) long by 8.75ft (2.6m) wide would contain 700ft³ (19.8m³).

NOTICE: This Heat Pump Water Heater may be located within a required minimum of 6in. (150mm) clearance from a wall on the outlet side, however for future service considerations, a minimum of 3ft (900mm) from any obstruction on the back, left and right side is recommended.

3 The floor can support the weight of a full water heater.

| Capacity | Filled Weight |
|--------------|---------------|
| 50 Gal./189L | 573lb (260kg) |
| 66 Gal./250L | 796lb (361kg) |
| 80 Gal./303L | 921lb (418kg) |

4 Your area is not prone to earthquakes. If it is, use special straps as required by local building codes.

5 The location is not prone to physical damage by vehicles, flooding, or other risks.

6 Avoid locations such as upper floors, or where a leak might damage the structure or furnishings. Due to the normal corrosive action of water, the tank will eventually leak. To minimize property damage from leaks, inspect and maintain your water heater in accordance with this manual's instructions. Inspect the drain pan, pipes, and surrounding area regularly and fix any leaks found. Drain pans are available at your local plumbing supplier. Leaks are frequently in the plumbing system itself and not the water heater.

7 The unit cannot be placed into any type of closet or small enclosure, unless adequate provisions are made for air exchange (vented or louvered doors, etc.).

8 To ensure optimal performance and serviceability, a minimum clearance of 6 inches must be maintained from all sides and 6in (150mm) from the top for access to the air filter.

9 The air filter, condensation drain and controls must be easily accessible for operation and service.

10 The site location must be free from any corrosive elements in the atmosphere such as sulphur, fluorine, sodium and chlorine. These elements are found in aerosol sprays, detergents, bleaches, air fresheners, paint and varnish removers, refrigerants and many other household products. In addition, excessive dust and lint may effect the operation of the unit, see the Air Filter Maintenance section in this manual.

11 The ambient air temperature must also be considered when installing this unit. In Efficiency Mode the air temperature needs to be above 45°F/7°C and below 120°F/49°C for heat pump operation. If the air temperature falls outside these upper and lower limits, the electrical elements will activate to meet the hot water demand and the heat pump does not operate in either Efficiency or Hybrid Mode.

INSTALLATION

Step 3:

Removing the old water heater

1 Read each installation step and decide if you have the necessary skills to install the water heater. Only proceed if you can safely perform the work. If you are not comfortable, have a qualified person perform the installation.

2 Locate the water heater's circuit breaker and turn it OFF (or remove the circuit's fuses).

3 On the old water heater, remove the electrical junction box access panel. Using a non-contact circuit tester, check the wiring to make certain the power is OFF.

▲ WARNING! Working on an energized circuit can result in severe injury or death from electrical shock.

4 Disconnect the electrical wires.

5 Open a hot water faucet and let the hot water run until it is cool (This may take 10 minutes or longer).



Figure 10 - Let the hot water run until it is cool.

▲ WARNING! Be sure the water runs cool before draining the tank to reduce the risk of scalding.

6 Connect a garden hose to the drain valve and place the other end of the hose in a drain, outside, or a bucket. (Note that sediment in the bottom of the tank may clog the valve and prevent it from draining. If you can't get the tank to drain, contact a qualified person.)

7 Turn the cold water supply valve OFF.

8 Open the drain valve on the water heater.



Figure 11 - Draining the old water heater.

9 Also open a hot water faucet to help the water in the tank drain faster.

10 When the tank is empty, disconnect the Temperature & Pressure (T&P) Relief Valve discharge pipe. You may be able to reuse the discharge pipe, but do not reuse the old T&P Relief Valve. A new T&P Relief Valve comes installed on your water heater (or on some models, is in the carton with the water heater).



Figure 12 - Removing the T&P Relief Valve discharge pipe.

11 Disconnect the water pipes. Many water pipes are connected by a threaded union which can be disconnected with wrenches. If you must cut the water pipes, cut the pipes close to the water heater's inlet and outlet connections, leaving the water pipes as long as possible. If necessary, you can make them shorter later when you install the new water heater.

12 Remove the old water heater.

▲ WARNING! Use two or more people to remove or install water heater. Failure to do so can result in back or other injury.

INSTALLATION

Step 4:

Installing the new water heater

1 Completely read all instructions before beginning. If you are not sure you can complete the installation, **DO NOT RETURN THIS UNIT TO THE STORE.** Seek assistance from any of the following sources:

- Schedule an appointment with a qualified person to install your water heater.
- Call our Technical Assistance Hotline at 1-888-479-8324

2 Install a suitable drain pan (if required) that is piped to an adequate drain.

3 Set the water heater in place taking care not to damage the drain pan.

NOTICE: The drain pan helps avoid property damage which may occur from condensation or leaks in the piping connections or tank. The drain pan must be at least two inches wider than the diameter of the water heater. Install the drain pan so the water level is limited to a maximum depth of 1-3/4in (45mm).

4 Verify that the water heater is set in place properly. Check that:

- The T&P Relief Valve will not be in contact with any electrical parts.
- There is adequate space to install the T&P Relief Valve discharge pipe and that it can be piped to a separate drain (and not into the drain pan).
- There is adequate space to install proper condensate drain piping.

- There is adequate access and space around the water heater for future maintenance. A minimum clearance of 6in (150mm) must be maintained from all sides and 6in (150mm) from the top for access to the air filter.
- Unit is level to allow proper condensate drainage. An unlevel unit may lead to condensate draining improperly and resulting in property damage.

DO NOT CONNECT ELECTRICAL WIRING UNTIL YOU ARE INSTRUCTED TO DO SO.

NOTICE: Connecting electrical power to the tank before it is completely full of water (water must run FULL STREAM from a hot water tap for a full three minutes) will cause the upper heating element to burn out.

Step 5:

Connecting the Condensate Pump When Required

NOTE: If no floor drain is available or the drain is above the level of the condensate line, a condensate pump must be installed.

1 Follow condensate drain pump manufacturers instructions for installation.

Connecting the Condensate Pump Optional Overflow Shut Off Switch

1 Locate the white 22 AWG wire loop inside the condensate drain access compartment by removing the 4 screws attaching the condensate drain access cover to the unit. Cut the loop and strip insulation off the 2 ends (Figure 13 & Figure 14).

2 Measure the distance from the condensate drain access cover to the condensate pump, and cut two 22 AWG wires to correct length and strip the insulation at both ends. Thread both ends through the grommet on the drain pan cover.

3 Connect these 2 wires to the 2 wires on the water heater using wire nuts or other connectors. Reinstall the condensate drain access cover and keep the connection joints inside of the cover.

4 Connect the free ends of the 2 wires to the shut off switch on the condensate pump in accordance with the condensate pump manufacturers recommendations.

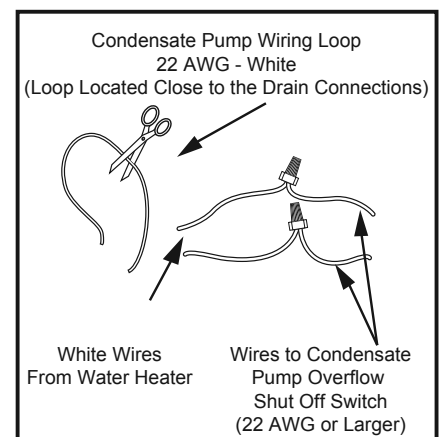

Figure 13 - Wiring Loop for connection of Condensate Pump.

INSTALLATION

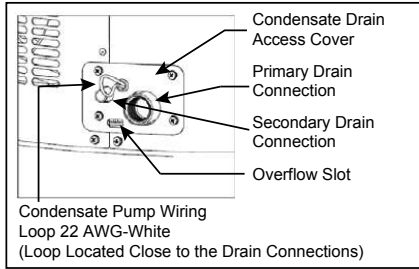

Figure 14 - Condensate Pump Wiring

Step 6:

Install Condensate Drain Lines:

NOTE: When making condensation connections to the primary connection DO NOT overtighten! These connections should be HAND TIGHTENED ONLY. Overtightening could crack or damage the condensate drain pan.

- Plastic pipe or tubing must be used to connect the condensate drain to a suitable drain or condensate pump.
- Do not connect condensate drain lines with other drain or discharge lines into a single (common) pipe or line. Each line (condensate drain line, temperature and relief valve discharge pipe, etc.) should be independently run to an adequate drain.
- Slope the condensate drain lines toward the inside floor drain or condensate pump.
- The condensate drain lines and connections to the drain piping must comply with all local codes.
- Use appropriate fittings and primer to cement the condensate drains to the heat pump drain pan.

- If a condensate pump is installed, it should be wired to shut off the heat pump in the event the condensate pump fails or the float switch in the pump activates (see “Step 5:”).

1 Using 3/4 in PVC piping, a 90° elbow that is 3/4 in slip & 3/4 in NPT and an approved sealant (none supplied with unit), attach the elbow to the primary drain connection and insert the PVC pipe into the female end allowing enough length to access an adequate drain.

2 Using 1/2” ID rubber or flexible plastic tubing, slip one end over the secondary drain connection allowing enough length to access an adequate drain.

Step 7:

Connect the Temperature and Pressure (T&P) Relief Valve/Pipe

Most T&P Relief Valves are pre-installed at the factory. In some cases, they are shipped in the carton and must be installed in the opening marked and provided for this purpose and according to local codes.

⚠ WARNING! To avoid serious injury or death from explosion, install a T&P Relief Valve according to the following instructions:

If your water heater does not have a factory installed T&P Relief Valve, install the new T&P Relief Valve that came with your water heater. Do not reuse an old T&P Relief Valve. Install a T&P Relief Valve discharge pipe according to local codes and the following guidelines:

1 The discharge pipe should be at least 3/4in inside diameter and sloped for proper drainage. Install it to allow complete drainage of both the T&P Relief Valve and the discharge pipe.

2 The discharge pipe must withstand 250°F (121°C) without distortion. Use only copper or CPVC pipe. Most homes use copper water pipes, or cross-linked polyethylene (PEX) but some use CPVC. Use fittings appropriate for the type of pipe in your home. Do not use any other type of pipe, such as PVC, iron, flexible plastic pipe, or any type of hose.



Figure 15 - The T&P Relief Valve discharge pipe must be installed properly and piped to an adequate drain.

INSTALLATION

- 3 Terminate the discharge pipe a maximum of 12" (300mm) above a floor drain, sump or other safe location. Do not drain the discharge pipe into the drain pan; instead pipe it separately to an adequate drain.

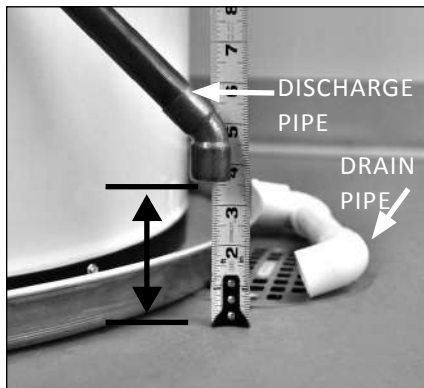

Figure 16 - The end of the T&P Relief Valve discharge pipe must stop no more than 12" (300mm) above a drain.

- 4 Do not place any valve or other restriction between the tank and T&P Relief Valve. Do not cap, block, plug, or insert any valve between the T&P Relief Valve and the end of the discharge pipe. Do not insert or install any reducer in the discharge pipe.

Step 8:

Install shutoff and mixing valves

- 1 If one is not already installed, install a manual shutoff valve in the cold water line that supplies the water heater. Install the shutoff valve near the water heater so that it is readily accessible. Only use valves that are compatible with potable water. Use only full-flow ball or gate valves. Other types of valves may cause excessive restriction to the water flow.

- 2 Install a Thermostatic Mixing Valve. Consult the valve manufacturer's instructions or a qualified person.



Figure 17 - Install Thermostatic Mixing Valves where required.

⚠ WARNING! Even if the water heater's thermostat(s) are set to a relatively low temperature, hot water can scald. Install Thermostatic Mixing Valves to reduce the risk of scalding.

- 3 For water heaters that are fed by a solar water heating system (or any other pre-heating system), always install a Thermostatic Mixing Valve or other temperature limiting device in the inlet water supply line to limit water supply inlet temperature to 140°F (60°C). Solar water heating systems can supply water with temperatures exceeding 170°F (77°C) and may result in water heater malfunction. Such a malfunction is not covered under the water heater warranty.

⚠ WARNING! Hot water provided by solar heating systems can cause severe burns instantly, resulting in severe injury or death (page 4).

Step 9:

Connect the water supply

- 1 Determine the type of water pipes in your home. Most homes use copper water pipes or cross-linked polyethylene (PEX) but some use CPVC. Use fittings appropriate for the type of pipe in your home. Do not use iron or PVC pipe – they are not suitable for potable water.

- 2 Connect the cold water supply using 3/4in National Pipe Thread "NPT" to the blue cold water connection near the bottom of the heater.

For ease of removing the water heater for service or replacement, connect the water pipes with a union. We recommend using a dielectric-type union (available at your local plumbing supplier). Dielectric unions can help prevent corrosion caused by tiny electric currents common in copper water pipes and can help extend the life of the water heater.

Recirculating Loop

In order to optimize efficiency of this unit, it is not recommended for use with a recirculation loop. Using this in a recirculation loop may cause the unit to run excessively.

INSTALLATION

IF YOU HAVE COPPER PIPES:

If your home has copper water pipes, you can solder the water pipe connections or use compression fittings which don't require soldering. Compression fittings are easier to install than soldering pipe. Check with local plumbing officials to determine what types of pipe materials are suitable for your location. Do not use lead-based solder.

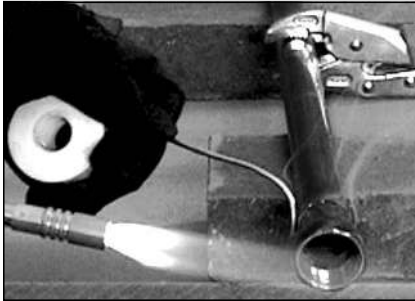

NOTICE: Do not solder pipes while they are attached to the water heater. The water heater's inlet and outlet connections contain non-metallic parts which could be damaged. The proper way to connect the water heater to copper water pipes is as follows:

- Solder a short length of pipe (about a foot or so) to a threaded adapter using only lead-free solder. Attach the threaded adapters to the water heater's connections (using Teflon® tape or pipe joint compound). Connect the home's water pipes by soldering, keeping the connections at the water heater cool with wet rags.

NOTE: Do not over apply joint compound.

NOTICE: This water heater model contains an outlet connection (J-tube) that has an orientation mark that must line up with arrow (in a 12 o'clock position).

- 3 Connect the hot water supply using 3/4in NPT to the hot water outlet. Follow the same connection guidelines as for the cold water supply.
- 4 Install insulation on the water pipes. Insulating the hot water pipes can increase energy efficiency.
- 5 Double check to make sure the hot and cold water pipes are connected to the correct hot and cold water fittings on the water heater.
- 6 If needed, install Pressure Reducing Valve and install a Thermal Expansion Tank.



Figure 18 - A Pressure Reducing Valve is required if your home's water pressure is above 80 psi/550kPa.



Figure 19 - The Thermal Expansion Tank should be pressurized with air, to match the home's incoming water pressure.

Step 10:

Verify connections and completely fill tank

To remove air from the tank and allow the tank to fill completely with water, follow these steps:

- 1 Remove the aerator at the nearest hot water faucet. This allows any debris in the tank or plumbing system to be washed out.
- 2 Turn the cold water supply back on.

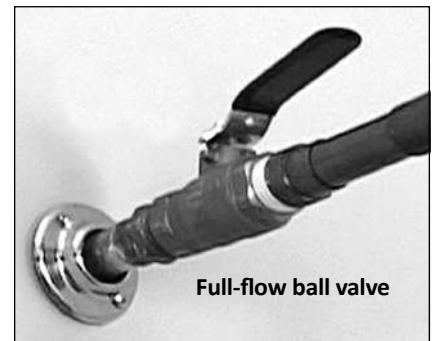

Figure 20 - Fully open the cold water supply valve.

INSTALLATION

- 3 Open a hot water faucet and allow the water to run until it flows with a full stream.
- 4 **Let the water run full stream for three full minutes.**
- 5 Close the hot water faucet and replace the aerator.
- 6 Check inlet and outlet connections and water pipes for leaks. Dry all pipes so that any drips or leaks will be apparent. Repair any leaks. Almost all leaks occur at connections and are not a tank leak.

Step 11:

Make electrical connections

▲ WARNING! Working on an energized circuit can result in severe injury or death from electrical shock.

NOTICE: Do not turn electrical power on unless you are sure all of the air is out of the tank and the tank is completely full of water. Although this water heater is equipped with “Dry Fire” protection, be certain all air is purged from the tank before making any electrical connections.

- 1 Be sure the electrical power to the water heater is turned OFF at the circuit breaker panel (or remove the circuit’s fuses).
- 2 Using a non-contact circuit tester, check the wiring to make certain the power is OFF.

- 3 This water heater requires a 240/208 VAC single phase 30 amp power supply, at 60Hz. Check the water heater’s data plate (see Figure 22) and ensure that the home’s voltage, wiring size (ampacity) and circuit breaker rating and type are correct for this water heater. Refer to the wiring diagram located on the water heater for the correct electrical connections. Ensure that wire sizes, type, and connections comply with all applicable local codes. In the absence of local codes, the current edition of the Canadian Electric Code (CEC).

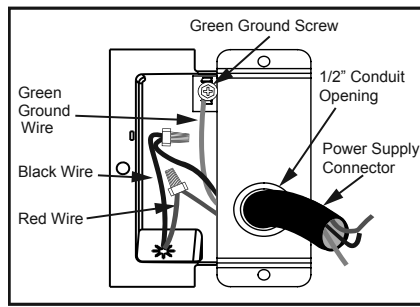

Figure 21 - Connecting the electrical wires.



Figure 22 - The water heater’s electrical requirements can be determined from the data plate.

- 4 Remove the cover on the electrical junction box on the side of the water heater.
- 5 Install wiring in an approved conduit (if required by local codes). Use a UL listed or CSA approved strain relief to secure the electrical wiring to the water heater.
- 6 Connect the ground wire to the green ground screw. Connect the home’s two power wires to the water heater’s two power wires. Use suitable wire nuts or other approved means to make the power connections.
- 7 Replace the junction box cover and secure with the screw provided.

▲ WARNING! Be sure cover is secured to reduce the risk of fire and electric shock.

INSTALLATION

Operation

The water heater is now ready for normal operation. To keep your water heater working safely and efficiently and extend its life, perform maintenance as described in maintenance section beginning on page 28.

Start-up and Operation

NOTE: The default operating mode is Hybrid, to select a different mode see “Operating Mode Descriptions” Section on page 17.

PRIOR TO BEGINNING OPERATION:

Air filter is factory installed with tabs oriented down for shipping. Please see maintenance section for instructions on removal, cleaning and replacing.

- 1** Turn on electrical power to the water heater.
- 2** Press the Mode/Enter button to set the operating mode.
NOTICE: The water heater will conduct a system diagnostic (approximately 8 minutes) prior to returning to operation.
- 3** Once the diagnostic sequence has finished, the fan should turn on. This typically takes 8 minutes, (the User Interface Module will display “-”, “--”, “---” repetitively during this period).
NOTICE: The heat pump’s fan will not turn on if the incoming water temperature is less than 59°F/15°C and/or the ambient air temperature is above 120°F/49°C, or below 45°F/7°C. Should the internal diagnostics detect a problem with the heat pump, an error code will be displayed.
- 4** Set the desired operational mode. For typical installations, the factory default mode, Hybrid Mode offers the best combination of efficiency and hot water

delivery. For detailed descriptions of all operational modes see “Adjusting the User Interface Module/Operational Modes” section.

Step 12:

Adjusting the Temperature

With the installation steps completed, you may adjust the water heater’s temperature setting if desired.

- 1** The water heater’s temperature setting has been factory set to approximately 140°F/60°C. Higher tank temperatures (140° F/60°C) kill bacteria that cause a condition known as “smelly water” and can reduce the levels of bacteria that cause water-borne diseases.



▲ WARNING! Higher temperatures increase the risk of scalding.

A mixing valve must be installed where required.



Figure 23 - Adjust Thermostat Mixing Valves to 120°F/49°C or lower.

To adjust the water heater’s temperature setting:

- The water temperature setting can be adjusted by using the Up and Down buttons   on the UIM (User Interface Module). Using the up or down buttons, cycle through the available temperature set points until the desired temperature is displayed. The temperature setting will blink on the display; press the Mode/Enter button to confirm the selection (see Figure 25).
 - The available temperature set points can be cycled through quickly by pressing and holding the Up button.
- 2** Please allow adequate time for the heater to provide hot water.

▲ WARNING! If the Thermostatic Mixing Valves are not set properly (or not installed) you could scald yourself while checking the temperature.

- 3** Check water temperature at several points of use in your home (for example, bathtub faucet, shower, or lavatory sink) and adjust the temperature as needed. If you aren’t sure how to adjust the Thermostatic Mixing Valve settings, or aren’t sure if you have Thermostatic Mixing Valves, contact a qualified person.

INSTALLATION

Post Installation Review

- 1 Understand how to use the User Interface Module to set the various modes and functions.
- 2 Hybrid Mode is the recommended Operating Mode. Understand the various Operating Modes and which mode may be best, based on ambient temperature and hot water demands.
- 3 Understand the importance of routine inspection/ maintenance of the condensate drain pan and lines. This is to prevent any possible drain line blockage resulting in the condensate drain pan overflowing.

NOTE: If water is coming from the overflow slot of the condensate drain access cover, this indicated that both condensate drain lines may be blocked and immediate action is required.

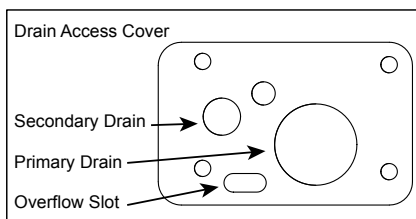



Figure 24 - Condensate Drain Access Cover

- 4 To maintain optimal operation, check, remove and clean the air filter as needed.
- 5 The Installation Instructions and Use and Care Guide should be kept with the water heater for reference.

Water Temperature Adjustment

The water temperature can be adjusted from 95°F / 35°C to 140°F / 60°C. Use the Up and Down Buttons   on the front panel to set the desired temperature (see Figure 25). The setting temperature will blink on the display, press Mode/Enter button to confirm.

The water temperature can be adjusted quickly by pressing the “Temperature Up” button and holding for three seconds.

NOTE: Before attempting to adjust the thermostat, read the “Water Temperature Regulation” section. If the instructions are not clear, contact a qualified person.

NOTE: For increased water demand, switching (temporarily) to Hybrid Mode or Electric Mode will decrease the recovery/re-heat time. Be sure to switch back to the desired operational mode when finished.

Operating Mode Descriptions

The operating modes can be changed sequentially by pressing the Mode/Enter button (Figure 25). The Operation Mode Indication Light will turn on when the relevant mode is selected.

This unit is equipped with technology that senses the hot water demand from the unit. While in Efficiency or Hybrid mode, during normal usage, the unit will operate the heat pump for maximum efficiency. In times that the water usage is above normal, this

unit has the ability to use one element (upper or lower) and the heat pump simultaneously to help improve recovery. This transition is seamless and will go unnoticed.

Efficiency Mode -

Provides the highest efficiency and lowest cost operation by using only the heat pump for heating. Recovery time and efficiency will vary with ambient temperature and relative humidity. Efficiency will be greatest, and recovery quickest, when both are high. At lower temperatures and relative humidity levels, efficiency will be lower and recovery will take longer. Heat pump operation is allowed between 45°F / 7°C to 120°F / 49°C ambient temperature. At ambient temperatures lower than 45°F / 7°C and greater than 120°F / 49°C, the heat pump will not operate. Similarly, if the water temperature in the tank is less than 59°F / 15°C, the heat pump will not operate. The unit will operate in electric mode until ambient and water temperatures return to the safe operating range of the heat pump.

INSTALLATION

Hybrid Mode -

This is the default, recommended setting, combining high energy efficiency with reduced recovery time. This mode uses the heat pump as the primary heating source. The heating element will heat water if demand exceeds a predetermined level so that the set point temperature can be recovered more quickly.

Electric Mode -

The water heater functions as a conventional electric unit, relying on only the elements for heat. This mode may be useful in periods of increased hot water demands. Electric Mode will remain for 48 hours before reverting back to default mode setting.

Vacation Mode -

The controller will not allow the temperature to drop below 60°F/15°C while in Vacation setting. This mode is recommended when the water heater is not in use for a long period of time, to minimize energy consumption and prevent the water heater from freezing during cold conditions.

▲ CAUTION! Hydrogen gas builds up in a hot water system when it is not used for a long period (two weeks or more). Hydrogen gas is extremely flammable. If the hot water system has not been used for two weeks or more, open a hot water faucet for several minutes at the kitchen sink before using any electrical appliances connected to the hot water system. Do not smoke or have an open flame or other ignition source near the faucet while it is open.

NOTE: When Vacation Mode is selected, the vacation timer will be displayed. Press the Up and Down button to modify the timer to desired number of vacation days (setting range: 1 to 99 days). The vacation timer will blink on the display; press the Mode/Enter button to confirm the vacation timer. To deactivate Vacation Mode, press the Mode/Enter button to switch to the desired mode.

NOTE: Do not shut off power to the unit for extended periods of time. If power must be turned off for an extended period of time, drain the tank completely.

Other Controls

°F/°C Switch - Press “Temperature Down” button and hold for 3 seconds to switch temperature unit between Fahrenheit and Celsius

Power Saver Enable/Disable:

- Press “Mode/Enter” button and hold for 3 seconds. The power saver feature will be activated and the display will show “P.S.” (not to be mistaken with P5), and the setting temperature alternatively. This feature allows the unit to be managed by grid or other utility based load management programs.
- To deactivate the power saver, press “Mode/Enter” button and hold for 3 seconds.

Heat pump defrosting indication:

- There will be frost accumulating on the evaporator when the heat pump is operated under low ambient temperatures. The controller will order the unit to enter into defrosting cycle to optimize the heat pump operation performance. During the defrosting period, the user interface module will display “ICE” as an indication.

Out of heat pump operation range:

- The user interface module will display “HPO” as an indication that the ambient and/or water temperature condition is out of the heat pump operation range.

NOTE: The display will go into “Sleep Mode” for energy saving if there is no operation on any button for 15 minutes. All the display and lights will be turned off except for the “Operational Mode Indication Light”, which will remain illuminated while the unit is powered on. The unit can be awakened by pressing any button.

INSTALLATION

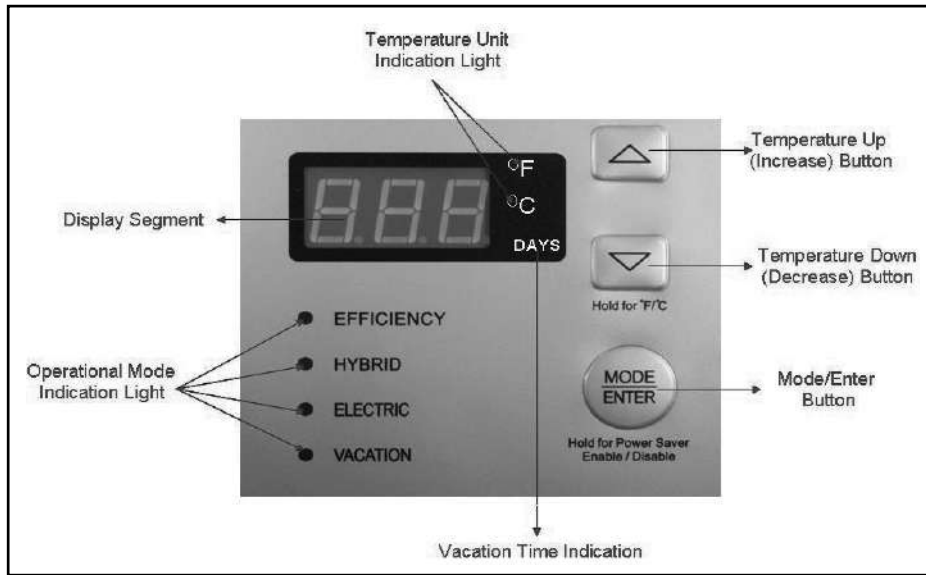

Figure 25 - User Interface Module (UIM) Display

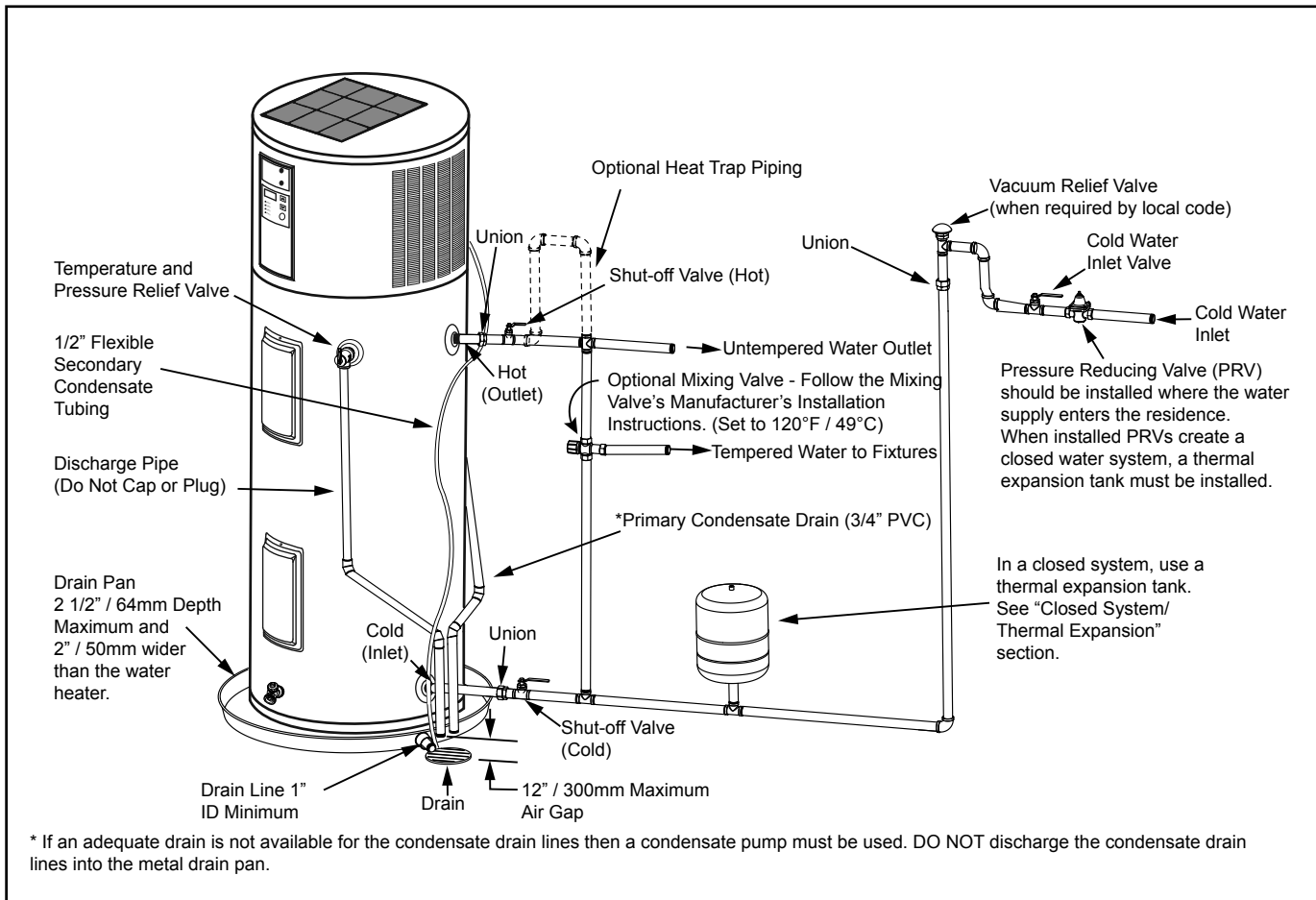

Figure 26 - Completed Water System Piping

INSTALLATION

DIAGNOSTIC CODES

| DISPLAY SHOWS | INDICATES | CORRECTIVE ACTION |
|---------------|---|---|
| "-","-","-" | Unit is doing a system diagnostic. | Normal operation--no action |
| ICE | Heat pump is in defrosting cycle. | |
| HPO | Ambient temperature 45°F-120°F (7.2°C-49°C), average tank temperature of 59°F (15°C) or less. | |
| EUC | Upper element is not functioning | <ol style="list-style-type: none"> 1. Turn off power at the circuit breaker/fuse box and check for a loose connection at the element. For access directions see "Replacing the Heating Element" Section on page 29. If error persists proceed to the next step. 2. Replace non-functioning element. See "Replacing the Heating Element" Section on page 29. |
| ELC | Lower element is not functioning | <ol style="list-style-type: none"> 1. Turn off power at the circuit breaker/fuse box and check for a loose connection at the element. For access directions see "Replacing the Heating Element" Section on page 29. If error persists proceed to the next step. 2. Replace non-functioning element. See "Replacing the Heating Element" Section on page 29. |
| SF | The air filter is dirty. | <ol style="list-style-type: none"> 1. Turn off power at the circuit breaker/fuse box. 2. Clean the air filter. See "Air Filter Maintenance" Section on page 32. |
| ECF | The heat pump compressor is starting/stopping frequently. | <ol style="list-style-type: none"> 1. Turn off power at the circuit breaker/fuse box. 2. Clean the air filter. See "Air Filter Maintenance" Section on page 32. 3. If error persist, please contact a qualified person to check the fan wire connection. |
| E20 or E21 | Upper Temperature Sensor is not functioning. | Contact a qualified person to service the unit. |
| E30 or E31 | Lower Temperature Sensor is not functioning. | |
| E50 or E51 | Heat Pump Suction Temperature Sensor is not functioning. | |
| E10 or E11 | Heat Pump Coil Temperature Sensor is not functioning. | |
| E40 or E41 | Heat Pump Discharge Temperature Sensor is not functioning. | |
| Edr | Not enough water in the tank (tank not full). This is also referred to as "Dry Fire". | Refer to "Verify connections and completely fill tank" Section on page 14 Open all hot water taps in home and run until water (uninterrupted) flows from all open hot water taps. |

TROUBLESHOOTING

NOTE: The diagnostic codes listed above are the most common. If a diagnostic code not listed above is displayed, contact Residential Technical Assistance referencing the number on the front of this manual.

DIAGNOSTIC CODES

| DISPLAY SHOWS | INDICATES | CORRECTIVE ACTION |
|--|--|---|
| EPL | Power supply voltage is too low. | Check the power supply to the unit and make sure it is higher than 187V. For further information refer to "Step 11:". |
| EDH | Heat Pump Discharge Temperature is too high. | Contact a qualified technician to service the unit. |
| EoF (If Accessory Condensate Pump is installed) | Condensate pump failure. | <ol style="list-style-type: none"> 1. Check to see if accessory condensate pump is plugged in and has power. Also check circuit breaker/fuse box and GFCI (if used). If error persists, proceed to the next step. 2. Check condensate pump outlet tube for blockage. If error persists, proceed to the next step. 3. Check control wire connections to condensate pump. If error persists, proceed to the next step. 4. Replace accessory condensate pump. If error persists, contact a qualified technician to service the unit. |
| ECL | Heat pump suction pressure is too low. | Contact a qualified technician to service the unit |
| EEE | EEPROM failure | |
| ECC | Heat pump compressor is not functioning. | |
| ECE | Power supply error. | |

NOTE: The diagnostic codes listed above are the most common. If a diagnostic code not listed above is displayed, contact Residential Technical Assistance referencing the number on the front of this manual.

TROUBLESHOOTING CHART

| PROBLEM | POSSIBLE CAUSE(S) | CORRECTIVE ACTION |
|---|--|---|
| “No Hot Water” on page 24 | <ol style="list-style-type: none"> No power to the water heater (No lights on the unit are on). Unit in Vacation mode ECO open Hot water usage pattern exceeds the capability of the water heater in current mode Non-functioning upper temperature sensor Faulty thermostatic mixing valve. Leak in plumbing system | <ul style="list-style-type: none"> Check for blown fuse or tripped breaker. Restore power to unit. Press Mode/Enter button and return to desired operating mode (page 17). Reset the Energy Cut Off (ECO) switch; see “To check the Energy Cut Off (ECO)” on page 25 Change to different mode or modify usage patterns (page 17). Contact a qualified person for service. Check hot water at other faucets. Check hot water side of home’s plumbing system for leaks. |
| “Insufficient Hot Water or Slow Hot Water Recovery” on page 26 | <ol style="list-style-type: none"> Temperature set-point too low Air filter dirty Hot water usage pattern exceeds the capability of the water heater in current mode Water connections to unit reversed Heat lost through long run of exposed pipe Hot water leak at faucet or piping Non-functioning heating element Sediment or scale build up in tank Incorrectly installed outlet j-tube. Thermostatic mixing valve faulty/set too low. Low supply voltage. | <ul style="list-style-type: none"> Increase set point temperature; see “Adjusting the Temperature” on page 16. Clean air filter (page 32). Change to different mode or modify usage patterns (For example if in Efficiency Mode switch to Hybrid Mode, page 17). Ensure the cold connection is at the bottom and that the hot connection is at the top. Insulate exposed piping Repair hot water leaks Call qualified person for service Drain and flush tank. Water conditioning may be necessary to minimize build up (page 28). Check orientation of alignment mark with arrow, re-install if necessary. Check hot water at other faucets. Contact utility company to verify voltage. |
| “Temperature Too High” on page 26 | <ol style="list-style-type: none"> Non functioning thermostat. Grounded/shorted heating element. Thermostatic mixing valve faulty. | <ul style="list-style-type: none"> Replace ECO (page 30). Replace heating element (page 29). Check hot water at other faucets. |
| “Low Water Pressure” on page 26 | <ol style="list-style-type: none"> Partially closed supply valve | <ul style="list-style-type: none"> Open supply valve completely. |
| “Water Odour” on page 25 | <ol style="list-style-type: none"> A concentration of sulfate in the supply water Little or no dissolved oxygen in the water A sulfate reducing bacteria which has accumulated within the water heater (this harmless bacteria is nontoxic to humans). An excess of active hydrogen in the tank. This is caused by the corrosion-protective action of the anode. | <ul style="list-style-type: none"> Contact qualified person for replacement of anode. |

TROUBLESHOOTING CHART

| PROBLEM | POSSIBLE CAUSE(S) | CORRECTIVE ACTION |
|--|--|--|
| “Water Heater Sounds” on page 26 | <ol style="list-style-type: none"> 1. Normal expansion and contraction of metal parts during periods of heat-up and cool-down. 2. Sediment buildup on or around the elements. 3. The heat pump compressor or fan running. | <ul style="list-style-type: none"> • No action required. • Drain and flush the tank as directed under the “Draining and Flushing” section (page 28). • No action required. |
| “Drips from T&P Relief Valve Discharge Pipe” on page 25 | <ol style="list-style-type: none"> 1. Excessive water pressure 2. Add or service a thermal expansion tank. 3. Non-functioning Temperature & Pressure Relief Valve 4. Debris under valve seat. | <ol style="list-style-type: none"> 1. Check water supply inlet pressure. If higher than 80 PSIG, install a pressure reducing valve. 2. See “Water Pressure Increase Caused by Thermal Expansion” section (page 7). 3. Replace the Temperature & Pressure Relief Valve 4. See “Drips from T&P Relief Valve Discharge Pipe” on page 25). |

TROUBLESHOOTING

⚠ WARNING! Working near an energized circuit can result in severe injury or death from electrical shock.

⚠ WARNING! When you are finished, be sure all covers are secured to reduce the risk of fire and electric shock.

No Hot Water

The most likely reasons for an electric water heater to produce NO hot water are:

- No electric power - a common problem with new installations
- Tripped ECO (Energy Cut Off)
- The water heater's inlet and outlet connections are reversed (usually only in new installations)
- A leak in the hot water side of the plumbing system that exceeds the water heater's heating capacity and makes it appear that the water heater is producing little to no hot water

Follow these steps to diagnose and correct common electrical problems:

1 Check the electrical power to the water heater. No hot water is often caused by a problem with the home's electrical wiring or circuit breakers. You'll need a non-contact circuit tester. Follow these guidelines:

- Locate the water heater's circuit breaker and turn it off (or remove the circuit's fuses).
- Locate the electrical junction box on the side of the water heater and remove the cover.
- Identify the two power wires. The power wires are usually black/black or black/red-the green or copper wire is the ground wire.



Figure 27 - Use a non-contact circuit tester to check for electrical power.

- Turn the circuit breaker back on (or install the fuses) and check the power on both incoming power wires using a non-contact circuit tester.
- Turn the power off and replace the cover on the electrical junction box.

If the water heater is not getting power, contact a qualified person to have your home's wiring or circuit breakers checked.

2 Check the upper heating element. If the water heater is getting electrical power, check to see if the upper heating element is burned out. If the upper element is burned out, you'll have no hot water. To check the upper element, you'll need a multimeter capable of reading resistance.

- Turn the power OFF at the circuit breaker or remove fuses.
- Remove the upper access panel.
- Move the insulation to the side to access the ECO and heating element.

3 Check the top two screws of the ECO using a non-contact circuit tester and confirm that power is off (screw terminals 1 and 3 in Figure 29).

- With the electrical power off, remove the two power wires from the upper heating element.

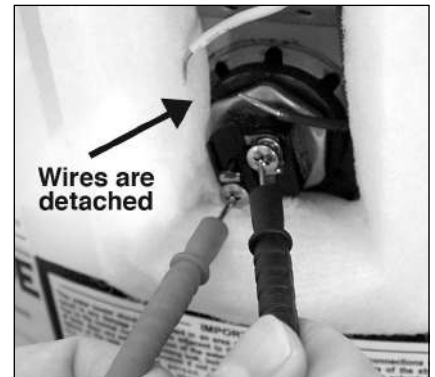

Figure 28 - Use a multi meter to check the resistance of the upper heating element.

4 Check the resistance of the upper heating element using a multimeter. Measure the resistance between the two screw terminals on the upper heating element. A good element will have a resistance ranging between 5 and 25 Ohms. If the resistance is:

Outside this range. Replace the element (see the "Routine Maintenance" on page 28). On a new water heater, a burned out element is almost always caused by turning the power on before the tank was completely full of water (Dry Fire).

Within this range. Reattach the power wires, making sure the wires are in good condition and the connections are clean and tight. Next check the following:

TROUBLESHOOTING

5

Check/Reset Energy Cut Off ECO Button.

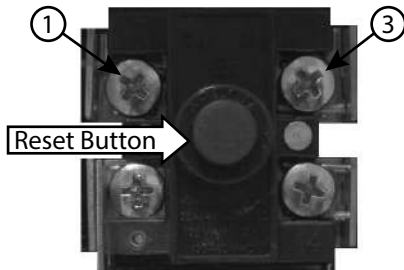

Figure 29 - Energy Cut Off (ECO) button
The Energy Cut Off (ECO) shuts off power to the water heater's elements if the temperature of the water in the tank gets too hot. If the ECO has tripped, you'll have no hot water. A tripped ECO can usually be reset, but you should have a qualified person investigate the cause of the overheating and repair the problem. DO not turn the power back on until the cause of the overheating has been identified and repaired.

To check the Energy Cut Off (ECO)

- Turn off the power to the water heater.

⚠ WARNING! Working near an energized circuit can result in severe injury or death from electrical shock. Check power wires in the electrical junction box with a non-contact circuit tester to make sure power is off.

- Press the red ECO reset button (see photo above).
- The ECO was tripped if you hear a click when it is reset. In most cases a tripped ECO indicates that the tank overheated due to a problem with one of the elements—have a qualified person check the upper and lower elements and replace if necessary.

- The ECO was not tripped if you didn't hear a click. In that case it should be checked by a qualified person.

- Replace the insulation and the upper access panel.
- Turn the power back on to the water heater.

⚠ WARNING! Be sure all covers are secured to reduce the risk of fire and electric shock.

Drips from T&P Relief Valve Discharge Pipe

A small amount of water dripping from the Temperature and Pressure (T&P) Relief Valve usually means the home's water pressure is too high or you need a properly sized and pressurized Thermal Expansion Tank. Refer to Step 1 in the Installation section of this manual for more information. A large amount of hot water coming from the T&P discharge pipe may be due to the tank overheating.

⚠ WARNING! Do not cap or plug the T&P relief valve or discharge pipe, and do not operate the water heater without a functioning T&P Relief Valve - this could cause an explosion.

Water pressure too high. High water pressure can cause the T&P Relief Valve to drip. Install a Pressure Reducing Valve (PRV) on the main cold water supply line. Adjust the PRV to less than 80 psi/550kPa.

Thermal Expansion Tank. Install a Thermal Expansion Tank. If a Thermal Expansion Tank is already installed and the T&P Relief Valve discharge pipe drips, the Thermal Expansion Tank may be pressurized to the wrong pressure or the internal bladder may be

defective. Refer to the instructions that came with the Thermal Expansion Tank for more information.

Debris. In rare cases, debris can stick inside the T&P Relief Valve preventing the valve from seating fully. In that case, the T&P Relief Valve discharge pipe will drip. You may be able to clear debris from the T&P Relief Valve by manually operating the valve, allowing small quantities of water to flush out the debris. See the label on the T&P Relief Valve for instructions.

If the water pressure is less than 80 psi/550kPa, a Thermal Expansion Tank is installed and properly pressurized, and the valve has been cleared of any debris, and it still drips, the valve may be broken—have a qualified person replace the T&P relief valve.

Water Odour

Harmless bacteria normally present in tap water can multiply in water heaters and give off a "rotten egg" smell. Although eliminating the bacteria that causes "smelly water" with a Chlorination system is the only sure treatment, in some cases, the standard anode rod that came with your water heater can be replaced with a special zinc anode rod which may help reduce or eliminate the odour. Contact a qualified person.

NOTE: To protect the tank, an anode rod must be installed in the water heater at all times or the warranty is void.

In cases where the "rotten egg" smell is pronounced, you can maintain the tank temperature at 140°F (60°C) in order to reduce bacteria growth in the tank.

TROUBLESHOOTING

Water Heater Sounds

During the normal operation of the water heater, sounds or noises may be heard. These noises are common and may result from the following:

- Normal expansion and contraction of metal parts during periods of heat-up and cool-down.
- Sediment buildup on or around the elements could create varying amounts of noise and may cause premature tank failure. Drain and flush the tank as directed under the “Draining and Flushing” section.

The heat pump compressor or fan running.

Temperature Too High

If the water temperature is too hot:

- Install or adjust the Thermostatic Mixing Valves or
- Adjust the thermostat(s) on the water heater (see “Step 10:” in the installation section of this manual).

A nonfunctioning thermostat or a shorted heating element can cause extremely hot water. If the Temperature and Pressure Relief Valve (T&P Valve) releases large amounts of very hot water, it is likely due to a shorted heating element, or more rarely a nonfunctioning thermostat, or the thermostat does not fit snugly against the tank. Very high water temperatures can also cause the Energy Cut Off (ECO) to trip (see page 24). Turn power off until this problem is fixed.

Low Water Pressure

Check both the cold and hot water at a sink to determine if the lower pressure is only on the hot water side. If both hot and cold faucets have low pressure, call your local water utility. If the low pressure is only on the hot water side, the primary causes of this are:

- Melted heat traps or dip tube. Soldering copper pipes while they are connected to the water heater can melt the heat traps inside the hot and cold water connections or the dip tube (cold water side). Melted heat traps or a melted dip tube can restrict the flow of hot water. If that’s the case, replace the heat traps or dip tube.

Partially closed supply valve. Open the water heater’s supply valve fully.

Insufficient Hot Water or Slow Hot Water Recovery

If the hot water is simply not warm enough, there are several possible causes:

- Faulty Thermostatic Mixing Valve in a faucet of shower control (check other faucets in the house for hot water).
- The User Interface Module (UIM) temperature set too low.
- Water heater’s capacity too small (or usage too high).
- Reversed plumbing connections or melted J-tube (usually found soon after installation).
- Plumbing leak
- Bad lower heating element
- Low supply voltage.

Thermostatic Mixing Valves. If the hot water is simply not warm enough, make sure the faucet you are checking doesn’t have a defective Thermostatic Mixing Valve. Many shower controls have built-in mixing valves. If these devices fail, they can reduce the amount of hot water the shower or faucet delivers even though there is plenty of hot water in the tank. Always check the water temperature at several faucets to make sure the problem is not in a faucet or shower control.

User Interface Module (UIM) set too low. If the water temperature at several faucets is too cool, adjust the UIM according to the instructions in “Step 12:” of the Installation section of this manual.

TROUBLESHOOTING

Undersized water heater. If your water heater runs out of hot water too quickly, it may be too small for your needs. If the water heater is old, consider replacing it with a larger model. If the water heater is in good condition, you may be able to meet your families hot water needs with the existing water heater by installing Thermostatic Mixing Valves at each point-of-use and then setting the temperature to a higher setting on the UIM. See “Step 12:”.

You can also reduce your homes hot water needs by washing clothes in cold water, installing flow restrictors on shower heads, repairing leaky faucets, and taking other conservative steps.

Reversed connections or melted J-tube. Check the hot and cold connections and make sure your homes hot water pipe is connected to the hot water outlet on the water heater. Usually reversed connections are found soon after the installation of a new unit. If copper pipes were soldered while they were attached to the water heater, the J-tube may have melted. The J-tube is a curved plastic tube inside the tank attached to the cold water inlet. If the J-tube has melted, it can be replaced by removing the old J-tube and installing a new one.

Plumbing leak. Even a small leak in the hot water side of the homes plumbing system can make it appear that the water heater is producing little or no hot water. Locate and repair the leak.

Lower heating element not working. If the lower heating element is not working, you will have some hot water but not as much as before. Because the lower element does most of the work, it usually wears out before the upper element. Replace the lower element if necessary (see page 29).

MAINTENANCE

Routine Maintenance

Routine maintenance will help your water heater last longer and work better. If you can't perform these routine maintenance tasks yourself, contact a qualified person.

Water Heater Maintenance

After the first six months, drain and flush the water heater and inspect the anode rod. Depending on the hardness of your water, repeat this process at least annually, or more frequently if needed. From time to time you may need to replace a heating element or a thermostat. All three maintenance tasks are described below.

Draining and Flushing the Water Heater

Tap water contains minerals that can form lime deposits on heating elements or sediment in the bottom of the tank. The amount of lime deposits or sediment depends on the hardness of your tap water. The rate at which sediment builds up depends on water quality and hardness in your area, the temperature settings, and other variables. We recommend draining and flushing the water heater after the first six months of operation to determine the amount of sediment build up. Draining sediment extends the life of the tank, heating elements, and drain valves.

- In areas with very hard water, remove and check the heating elements whenever you drain the tank. If you have heavy lime deposits on heating elements, you will need to replace them more often.

- Sediment may form large masses that can prevent the tank from draining. Have a qualified person use a de-liming agent suitable for potable water to remove the sediment buildup.
- In most cases, it is easier and cheaper to replace lime-encrusted elements than trying to remove heavy lime deposits.

To drain and flush the tank:

- 1 Locate the water heater's circuit breaker and turn it OFF (or remove the circuit's fuses).



Figure 30 - Circuit Breaker

- 2 Open a hot water faucet and let the hot water run until it is cool.



Figure 31 - Water Faucet

▲ WARNING! Be sure the water runs cool before draining the tank to reduce the risk of scalding.

- 3 Connect a garden hose to the drain valve and place the other end of the hose in a drain, outside, or in buckets.
- 4 Turn the cold water supply valve OFF.

- 5 Open the drain valve on the water heater.



Figure 32 - Drain Valve

- 6 Open a hot water faucet to help the water in the tank drain faster.

NOTICE: DO NOT turn electrical power back on unless the tank is completely full of water. This is an additional precaution to protect the elements against dry fire. Dry fire occurs when power is supplied to the electric elements without sufficient water in the heater. Dry firing the unit will result in reduced life of the element or potential immediate failure of the element. While this unit is equipped with dry fire protection the recommended practice is to ensure the tank is filled with water prior to supplying power to the unit.

- 7 Remove and inspect the anode rod (see Repair Parts Illustration on back cover for location of the anode rod). Replace the anode rod if it is depleted.



Figure 33 - Anode Rods from new (top) to partially depleted (middle) to fully depleted staged (bottom)

MAINTENANCE

Anode Rod. The anode rod is a sacrificial metal rod that helps reduce corrosion and premature failure (leaks) in the tank. The anode rod is a consumable item. Inspect the anode rod after the first six months of operation when you drain and flush the tank. Replace the anode rod if it is substantially worn out or depleted. Thereafter, inspect the anode rod annually or more frequently if needed. If you use a water softener, your anode rod will deplete faster than normal. Inspect the anode rod more frequently, replacing the anode rod as needed. Obtain new anode rods from your local plumbing supplier or have a qualified person replace it. (Anode rods are a consumable item and are not covered under warranty).

8 If the sediment was present when the tank was drained, flush the tank by opening the cold water supply valve and letting the water run until no more sediment drains from the tank. Close the drain valve when you are done.

NOTICE: Do not turn power back on until the tank is completely full of water. For complete instructions on filling the tank, follow “Step 10:” in the Installation section.

9 Refill the tank by opening the cold water supply valve. Make sure a hot water faucet is open and the drain valve is closed. Allow the hot water to run full for at least three minutes to make sure the tank has all the air removed and is completely full of water. Failure to perform this step can cause the upper heating element to burn out. Once you are certain the tank is completely full of water, close the hot water faucet.

10 Restore power to the water heater. It may take two hours for the tank to heat up.

Replacing the Heating Element

⚠ WARNING! Working on an energized circuit can result in severe injury or death from electrical shock. Turn power off. Check wires with a non-contact circuit tester to make sure power is off. When you are finished, be sure all covers are secured to reduce the risk of fire and electric shock.

If you are not comfortable replacing a heating element or thermostat yourself, have this work done by a qualified person. To replace the heating element, you’ll need the following tools and supplies:



Figure 34 - Non-Contact Circuit Tester

- Always turn power OFF and check the power wires with a non-contact circuit tester before working on the water heater.



Figure 35 - Heating Element (with gasket)

- Check your water heater’s data plate for the correct wattage and voltage. Heating elements are available your local plumber supplier.



Figure 36 - Element Wrench

- Some regular sockets (1.5in) may work, but regular sockets are often beveled and may slip. Inexpensive element wrenches are available at your local plumber supplier.
- Garden hose to drain the tank
- Hand dishwashing soap to lubricate the gasket
- A clean cloth to clean the threaded opening
- A flat blade and a Phillips screw-driver

Steps for Replacing the Heating Element:

- 1** Turn the power OFF at the circuit breaker or remove fuses.



Figure 37 - Circuit Breaker

- 2** Open the electrical junction box on the side of the water heater. Using a non-contact circuit tester, check the power wires to make certain the power is OFF.



Figure 38 - Non-Contact Circuit Tester

MAINTENANCE

- 3 Open a hot water faucet and let the hot water run until it is cool.



Figure 39 - Water Faucet

▲ WARNING! Be sure the water runs cool before draining the tank to reduce the risk of scalding.

- 4 Connect a garden hose to the drain valve and place the other end of the hose in a drain or outside (or use buckets). Turn OFF the cold water valve that supplies the water heater. Open the drain valve on the water heater. Opening a hot water faucet will help the tank drain faster.

- 5 Remove the upper or lower access panel on the water heater, and then fold back the insulation and remove the plastic element/thermostat cover.



Figure 40 - Access Panel

- 6 With the tank drained and power off, remove the power wires from the element you intend to replace.
- 7 Remove the bad element using an element wrench.

- 8 Make sure the new element is the correct replacement by referring to the water heater's data plate for voltage and wattage information.

- 9 Clean the threads in the tank opening with a rag. Insert the new element equipped with a rubber gasket. **NOTE:** Use a drop of hand dishwashing liquid to lubricate the gasket to help avoid damaging the gasket as it is being tightened. Tighten with an element wrench.

NOTICE: Do not turn power back on until the tank is completely full of water. For complete instructions on filling the tank, follow "Step 10:" in the Installation section.

- 10 Refill the tank by opening the cold water supply valve. Make sure a hot water faucet is open and the drain valve is closed. Allow the hot water to run full for at least three minutes to make sure the tank has all the air removed and is completely full of water. Failure to perform this step can cause the upper heating element to burn out. Once you are certain the tank is completely full of water, close the hot water faucet.



Figure 41 - Drain Valve

- 11 Check the newly installed element for leaks. If a leak is present, tighten the element until the leak stops. If you cannot stop the leak, drain the tank and remove the element. Inspect the gasket for damage. If the gasket is damaged, replace the gasket and re-install the element.

- 12 Once the element is successfully installed and there are no leaks, replace the power wires, thermostat cover, insulation, and access panel. Make sure all wire connections are tight. Replace the cover on the electrical junction box.

- 13 Restore power to the water heater. It may take two hours for the tank to heat up.

Replacing the ECO

▲ WARNING! Working on an energized circuit can result in severe injury or death from electrical shock. Turn power off. Check wires with a non-contact circuit tester to make sure power is off. When you are finished, be sure all covers are secured to reduce the risk of fire and electric shock.

To replace the ECO, you'll need the following tools and supplies:

- A non-contact circuit tester. Always turn power OFF and check with a non-contact circuit tester before working on the water heater.

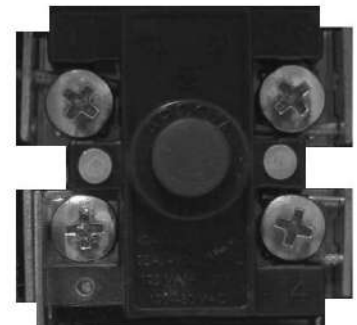

Figure 42 - ECO

MAINTENANCE

- A replacement ECO (available by calling the number in the “REPAIR PARTS LIST” on page 33). A business card to check the gap between the ECO and tank.
- Tape and a permanent marker to mark the wires
- A flat blade and a Phillips screw-driver

Steps for Replacing the ECO:

- 1 Turn the power OFF at the circuit breaker or remove fuses.

NOTICE: It is not necessary to drain the tank to replace an ECO.

- 2 Open the electrical junction box the side of the water heater. Using a non-contact circuit tester, check the power wires to make certain the power is OFF.

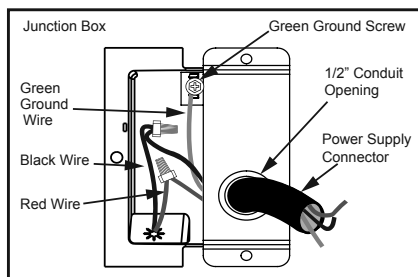

Figure 43 - Non-Contact Circuit Tester

- 3 Remove the upper access panel on the water heater and carefully fold back the insulation and plastic element/ECO cover (see Figure 40).
- 4 Make sure the replacement ECO matches the original ECO.
- 5 Mark the wires with tape so you'll know how to put them back on.

- 6 Disconnect the wires from the bad ECO and remove the ECO from the metal mounting clip.
- 7 Install the new ECO in the metal mounting clip.
- 8 Make sure the new ECO fits snugly against the tank. You should NOT be able to slip a business card between the ECO and the tank. If you can, bend the ECO mounting clip until the ECO fits tightly against the tank.

- 9 Attach the wires following the wiring diagram on the water heater's label. Make sure all wire connections are tight.

- 10 Replace the plastic element/ECO cover, insulation, and access panel.

- 11 Replace the cover on the electrical junction box.

- 12 Restore power to the water heater. It may take two hours for the tank to heat up.



Figure 44 - Element Access Panel/ECO Compartment

T&P Relief Valve Maintenance

Read and follow the operating and annual maintenance instructions provided by the manufacturer of the T&P Relief Valve (yellow label attached to T&P Relief Valve). Minerals in the water can form deposits that cause the valve to stick or create blocked passages, making the T&P Relief Valve inoperative. Follow these guidelines:

- At least annually, operate the T&P Relief Valve manually to ensure the waterways are clear and the valve mechanism moves freely (above). Before operating the valve manually, check that it will discharge in a place for secure disposal. If water does not flow freely from the end of the discharge pipe, turn OFF the power to the water heater. Call a qualified person to determine the cause.

⚠ WARNING! Hot water will be released. Before operating the T&P relief valve manually, check that it will discharge in a safe place. If water does not flow freely from the end of the discharge pipe, turn the power to the water heater OFF. Call a qualified person to determine the cause.



Figure 45 - T&P Relief Valve

- At least every five years, have a qualified person inspect the T&P Relief Valve and discharge pipe.

MAINTENANCE

- Damage caused by corrosive water conditions, mineral deposits, or other problems can only be determined when a qualified person removes and inspects the valve and its components.
- Note that a dripping T&P Relief Valve is usually caused by the home's water pressure being too high or the lack of a Thermal Expansion Tank. If your T&P Relief Valve drips refer to "Drips from T&P Relief Valve Discharge Pipe" on page 25.

Air Filter Maintenance

The heater will monitor the heat pump operation status and indicate whether the filter should be cleaned. If the User Interface Module displays "SF" code, this indicates the filter should be cleaned or replaced with the following process (See exploded view of unit on last page for air filter location).

NOTE: Before attempting to clean or replace the air filter, turn off power to the water heater at the circuit breaker/fuse box.

- 1** Take the two tabs on the air filter and remove (slide) it from the top cover of the unit.
- 2** If you are replacing the filter, skip to step four. To clean the filter, use a vacuum with a hose attachment to remove any dust or debris.
- 3** Place the new or cleaned filter into the water heater.
- 4** Restore power to the water heater and turn the water heater on.

NOTE: The water heater may conduct a system diagnostic prior to operation.

Condensate Drain Maintenance

NOTE: Before attempting to clean the condensate drain pan or lines shut off power to the water heater at the circuit breaker/fuse box.

- 1** Remove the top shroud by loosening the screws securing it to the unit.
- 2** Check the condensate drain pan and drain lines for any dirt or debris that might interfere with proper drainage. Wipe out any dirt or debris with a damp cloth.
- 3** Once the condensate drain pan and lines have been inspected/cleaned, secure the shroud back to the top of the water heater.
- 4** Restore power to the water heater and turn the water heater on.

NOTE: The water heater will conduct a system diagnostic prior to operation.

REPAIR PARTS ILLUSTRATION

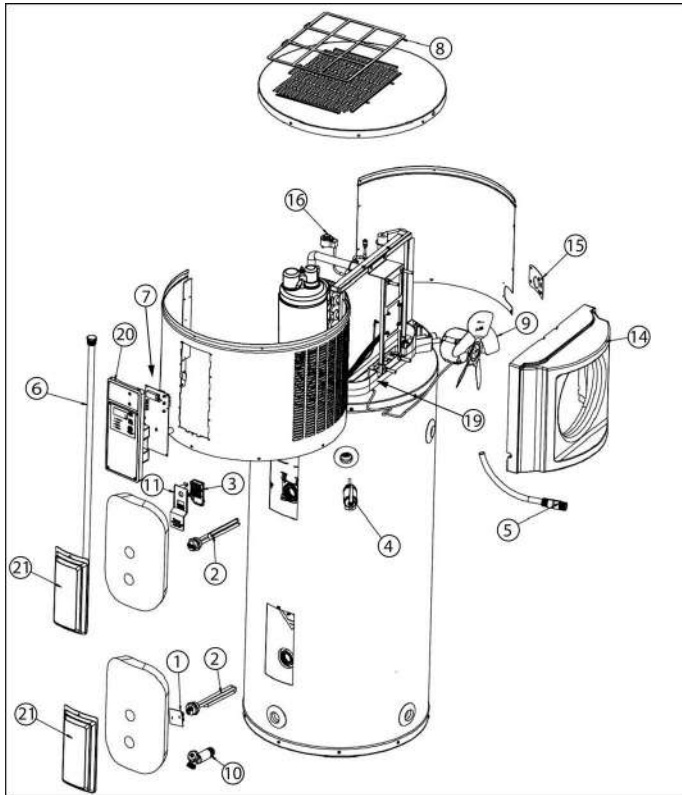

REPAIR PARTS LIST

| ITEM NO. | PARTS DESCRIPTION |
|----------|---|
| 1 | Element Access Cover |
| 2 | Element (4500 Watts) |
| 3 | Energy Cut-Off (ECO) Switch |
| 4 | Temperature & Pressure Relief Valve (T&P) |
| 5 | J-Tube (at hot water outlet; sizes for J-tubes are dependent upon capacity of water heater) |
| 6 | Anode (Optional for 50gal/189.3L and 66gal/249.8L models) |
| 7 | Controller |
| 8 | Air Filter |
| 9 | Fan Assembly |
| 10 | Drain Valve - Brass - 2 inch |
| 11 | Personnel Protector |
| 12 | Ambient / Coil / Discharge Temperature Sensor Assembly* |
| 13 | Upper / Lower Tank Temperature Sensor Assembly* |
| 14 | Fan Shroud |
| 15 | Condensate Drain Access Cover |
| 16 | Electronic Expansion Valve Coil |
| 17 | Run Capacitor* |
| 18 | Relay Kit* |
| 19 | Condensate Drain Pan |
| 20 | Smart Grid Cover |
| 21 | Element Access Panel |
| 22 | Condensation Pump Wiring Harness* |
| 23 | Anode (Optional for 66gal/249.8L and 80gal/302.8L models)* |
| 24 | Anode (Optional for 80 gallon models)* |

REPAIR PARTS

Repair parts may be ordered through your plumber, local distributor, home improvement center. For information about where to get parts in your area, visit our website at www.hotwatercanada.ca or call 1-888-479-8324. When ordering repair parts always give the following information:

1. Model, serial and product number
2. Item number
3. Parts description

* NOT SHOWN



A.O. Water Heaters

599 Hill Street West

Fergus, ON Canada N1M 2X1

Should you have any questions, please

Visit us online at www.hotwatercanada.ca, or

Call our Technical Support line at 1-888-479-8324

Copyright © 2015, Inc. All Rights Reserved

®Teflon is a registered trademark of E.I. Du Pont De Nemours and Company